

JVC

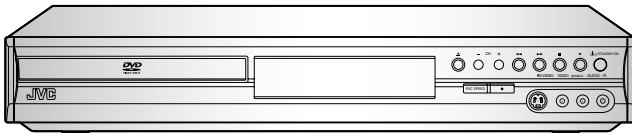

DVD VIDEO RECORDER

DR-M70SU



VCR Plus+ and PlusCode are registered trademarks of Gemstar Development Corporation. The VCR Plus+ system is manufactured under license from Gemstar Development Corporation.

INSTRUCTIONS

For Customer Use :

Read carefully the information located at the back of this unit and enter below the Serial No. Retain this information for future reference.

Model No. _____

Serial No. _____

EN

Before you start

Precautions

WARNING: TO REDUCE THE RISK OF FIRE OR ELECTRIC SHOCK, DO NOT EXPOSE THIS APPLIANCE TO RAIN OR MOISTURE.



CAUTION
RISK OF ELECTRIC SHOCK
DO NOT OPEN



CAUTION:

TO REDUCE THE RISK OF ELECTRIC SHOCK, DO NOT REMOVE COVER (OR BACK). NO USER SERVICEABLE PARTS INSIDE. REFER SERVICING TO QUALIFIED SERVICE PERSONNEL.



The lightning flash with arrowhead symbol, within an equilateral triangle, is intended to alert the user to the presence of uninsulated "dangerous voltage" within the product's enclosure that may be of sufficient magnitude to constitute a risk of electric shock to persons.



The exclamation point within an equilateral triangle is intended to alert the user to the presence of important operating and maintenance (servicing) instructions in the literature accompanying the appliance.

The rating plate and the safety caution are on the rear and the bottom of the unit.

Laser Safety

This unit employs a laser. Only a qualified service person should remove the cover or attempt to service this device, due to possible eye injury.

CAUTION: USE OF CONTROLS OR ADJUSTMENTS OR PERFORMANCE OF PROCEDURES OTHER THAN THOSE SPECIFIED HEREIN MAY RESULT IN HAZARDOUS RADIATION EXPOSURE.

CAUTION: VISIBLE AND INVISIBLE LASER RADIATION WHEN OPEN AND INTERLOCK DEFEATED. DO NOT STARE INTO BEAM.

LOCATION: INSIDE, NEAR THE DECK MECHANISM.

FCC WARNING- This equipment may generate or use radio frequency energy. Changes or modifications to this equipment may cause harmful interference unless the modifications are expressly approved in the instruction manual. The user could lose the authority to operate this equipment if an unauthorized change or modification is made.

RADIO-TV INTERFERENCE

This equipment has been tested and found to comply with the limits for a Class B digital device, pursuant to Part 15 of the FCC Rules. These limits are designed to provide reasonable protection against harmful interference in a residential installation. This equipment generates, uses, and can radiate radio frequency energy and, if not installed and used in accordance with the instructions, may cause harmful interference to radio communications. However, there is no guarantee that interference will not occur in a particular installation. If this equipment does cause harmful interference to radio or television reception, which can be determined by turning the equipment off and on, the user is encouraged to try to correct the interference by one or more of the following measures:

- 1) Reorient or relocate the receiving antenna.
- 2) Increase the separation between the equipment and receiver.
- 3) Connect the equipment into an outlet on a circuit different from that to which the receiver is connected.
- 4) Consult the dealer or an experienced radio/TV technician for help.

This Class B digital apparatus complies with Canadian ICES-003.

Cet appareil numérique de la classe B est conforme à la norme NMB-003 du Canada.

CAUTION: TO PREVENT ELECTRIC SHOCK, MATCH WIDE BLADE OF PLUG TO WIDE SLOT, FULLY INSERT.

ATTENTION: POUR ÉVITER LES CHOC ÉLECTRIQUES, INTRODUIRE LA LAME LA PLUS LARGE DE LA FICHE DANS LA BORNE CORRESPONDANTE DE LA PRISE ET POUSSER JUSQU'AU FOND.

A NOTE ABOUT RECYCLING

This product's packaging materials are recyclable and can be reused. Please dispose of any materials in accordance with your local recycling regulations.

Batteries should never be thrown away or incinerated but disposed of in accordance with your local regulations concerning chemical wastes.

Make your contribution to the environment!!!

- Used up batteries do not belong in the dust bin.
- You can dispose of them at a collection point for used up batteries or special waste. Contact your council for details.



IMPORTANT SAFEGUARDS

1. Read Instructions - All the safety and operating instructions should be read before the appliance is operated.
2. Retain Instructions- The safety and operating instructions should be retained for future reference.
3. Heed Warnings - All warnings on the appliance and in the operating instructions should be adhered to.
4. Follow Instructions - All operating and use instructions should be followed.
5. Cleaning - Unplug this product from the wall outlet before cleaning. Do not use liquid cleaners or aerosol cleaners. Use a damp cloth for cleaning.
EXCEPTION: A product that is meant for uninterrupted service and, that for some specific reason, such as the possibility of the loss of an authorization code for a CATV converter, is not intended to be unplugged by the user for cleaning or any other purpose, may exclude the reference to unplugging the appliance in the cleaning description otherwise required in item 5.
6. Attachments - Do not use attachments not recommended by the product manufacturer as they may cause hazards.
7. Water and Moisture- Do not use this product near water, for example, near a bath tub, wash bowl, kitchen sink, or laundry tub, in a wet basement, or near a swimming pool, and the like.
8. Accessories - Do not place this product on an unstable cart, stand, tripod, bracket, or table. The product may fall, causing serious injury to a child or adult, and serious damage to the appliance. Use only with a cart, stand, tripod, bracket, or table recommended by the manufacturer, or sold with the product. Any mounting of the appliance should follow the manufacturer's instructions and should use a mounting accessory recommended by the manufacturer. An appliance and cart combination should be moved with care. Quick stops, excessive force, and uneven surfaces may cause the appliance and cart combination to overturn.
PORTABLE CART WARNING
(Symbol provided by RETAC)

S3125A
9. Ventilation - Slots and openings in the cabinet are provided for ventilation and to ensure reliable operation of the product and to protect it from overheating, and these openings must not be blocked or covered. The openings should never be blocked by placing the product on a bed, sofa, rug, or other similar surface. This product should not be placed in a built-in installation such as a bookcase or rack unless proper ventilation is provided or the manufacturer's instructions have been adhered to.
10. Power Sources - This product should be operated only from the type of power source indicated on the marking label. If you are not sure of the type of power supply to your home, consult your appliance dealer or local power company. For products intended to operate from battery power, or other sources, refer to the operating instructions.
11. Grounding or Polarization - This product is equipped with a polarized alternating-current line plug (a plug having one blade wider than the other). This plug will fit into the power outlet only one way. This is a safety feature. If you are unable to insert the plug fully into the outlet, try reversing the plug. If the plug should still fail to fit, contact your electrician to replace your obsolete outlet. Do not defeat the safety purpose of the polarized plug.
12. Power Cord Protection - Power supply cords should be routed so that they are not likely to be walked on or pinched by items placed upon or against them, paying particular attention to cords at plugs, convenience receptacles, and the point where they exit from the appliance.
13. Outdoor Antenna Grounding - If an outside antenna or cable system is connected to the product, be sure the antenna or cable system is grounded so as to provide some protection against voltage surges and built-up static charges. Article 810 of the National Electrical Code, ANSI/NFPA No. 70, provides information with regard to proper grounding of the mast and

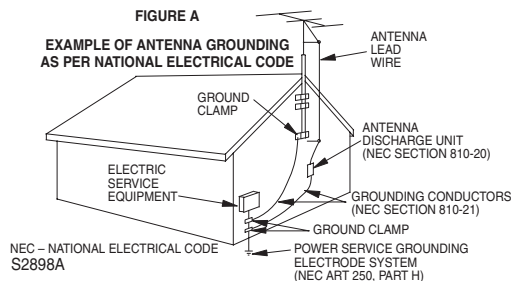
supporting structure, grounding of the lead-in wire to an antenna discharge unit, size of grounding conductors, location of antenna-discharge unit, connection to grounding electrodes, and requirements for the grounding electrode. (Fig. A)



14. Lightning - For added protection for this product during a lightning storm, or when it is left unattended and unused for long periods of time, unplug it from the wall outlet and disconnect the antenna or cable system. This will prevent damage to the product due to lightning and power-line surges.
15. Power Lines - An outside antenna system should not be located in the vicinity of overhead power lines or other electric light or power circuits, or where it can fall into such power lines or circuits. When installing an outside antenna system, extreme care should be taken to keep from touching such power lines or circuits as contact with them might be fatal.
16. Overloading - Do not overload wall outlets and extension cords as this can result in a risk of fire or electric shock.
17. Object and Liquid Entry - Never push objects of any kind into this product through any openings as they may touch dangerous voltage points or short-out parts that could result in a fire or electric shock. Never spill liquid of any kind on the product.
18. Servicing - Do not attempt to service this product yourself as opening or removing covers may expose you to dangerous voltage or other hazards. Refer all servicing to qualified service personnel.
19. Damage Requiring Service - Unplug this product from the wall outlet and refer servicing to qualified service personnel under the following conditions:
 - a. When the power-supply cord or plug is damaged.
 - b. If liquid has been spilled, or objects have fallen into the product.
 - c. If the product has been exposed to rain or water.
 - d. If the product does not operate normally by following the operating instructions. Adjust only those controls that are covered by the operating instructions as an improper adjustment of other controls may result in damage and will often require extensive work by a qualified technician to restore the product to its normal operation.
 - e. If the product has been dropped or damaged in any way.
 - f. When the product exhibits a distinct change in performance this indicates a need for service.
20. Replacement Parts - When replacement parts are required, be sure the service technician has used replacement parts specified by the manufacturer or have the same characteristics as the original part. Unauthorized substitutions may result in fire, electric shock or other hazards.
21. Safety Check - Upon completion of any service or repairs to this product, ask the service technician to perform safety checks to determine that the product is in proper operating condition.
22. Heat - This product should be situated away from heat sources such as radiators, heat registers, stoves, or other products (including amplifiers) that produce heat.

Before you start

Precautions (cont'd)

Installation Location

For safety and optimum performance of this unit:

- Install the unit in a horizontal and stable position. Do not place anything directly on top of the unit. Do not place the unit directly on top of the TV.
- Shield it from direct sunlight and keep it away from sources of intense heat. Avoid dusty or humid places. Avoid places with insufficient ventilation for proper heat dissipation. Do not block the ventilation holes on the sides of the unit. Avoid locations subject to strong vibration or strong magnetic fields.

Avoid the Hazards of Electrical Shock and Fire

- Do not handle the power cord with wet hands.
- Do not pull on the power cord when disconnecting it from AC wall outlet. Grasp it by the plug.
- If, by accident, water is spilled on this unit, unplug the power cord immediately and take the unit to our Authorized Service Center for servicing.

Moisture Condensation Warning

Moisture condensation may occur inside the unit when it is moved from a cold place to a warm place or after heating a cold room or under conditions of high humidity. Do not use this unit at least for 2 hours until its inside gets dry.

About Copyright

Unauthorized copying, broadcasting, public performance and lending of discs are prohibited.

This product incorporates copyright protection technology that is protected by U.S. patents and other intellectual property rights. Use of this copyright protection technology must be authorized by Macrovision, and is intended for home and other limited viewing uses only unless otherwise authorized by Macrovision.

Reverse engineering or disassembly is prohibited.

Notice for progressive scan outputs

Consumers should note that not all high definition television sets are fully compatible with this product and may cause artifacts to be displayed in the picture. In case of picture problems with 525 progressive scan output, it is recommended that the user switch the connection to the 'standard definition' output. If there are questions regarding your TV set compatibility with this 525p DVD recorder, please contact our customer service center.

"DTS" and "DTS Digital Out" are trademarks of Digital Theater Systems, Inc.

Manufactured under license from Dolby Laboratories. "Dolby" and the double-D symbol are trademarks of Dolby Laboratories.

Dolby Digital Recording

"Dolby® Digital Recording enables consumers to record high-quality video with stereo sound on recordable DVD discs. The technology, when utilized instead of PCM recording, also saves recordable disc space, allowing for higher video resolution or extended recording time on each DVD. DVDs created using Dolby Digital Recording will play back on all DVD-Video players."

Note: This is true when the players are compatible with actual recordable DVD discs.

Before you start

Precautions (cont'd)

Maintenance

SERVICING

- Please refer to relevant topics on the Troubleshooting on pages 79-82 before returning the product.
- If this unit becomes inoperative, do not try to correct the problem by yourself. There are no user-serviceable parts inside. Turn off, unplug the power plug and please call our help line mentioned on the back cover to locate an Authorized Service Center.

CLEANING THE CABINET

- Use a soft cloth slightly moistened with a mild detergent solution. Do not use a solution containing alcohol, spirits, ammonia or abrasive.

CLEANING DISCS

- When a disc becomes dirty, clean it with a cleaning cloth. Wipe the disc from the center out. Do not wipe in a circular motion.
- Do not use solvents such as benzene, thinner, commercially available cleaners, detergent, abrasive cleaning agents or antistatic spray intended for analogue records.

CLEANING THE DISC LENS

- If this unit still does not perform properly although you refer to the relevant sections and to "TROUBLESHOOTING" in this Owner's Manual, the laser optical pickup unit may be dirty. Consult your dealer or an Authorized Service Center for inspection and cleaning of the laser optical pickup unit.

DISC HANDLING

- Handle the discs so that fingerprints and dust do not adhere to the surfaces of the discs.
- Always store the disc in its protective case when it is not used.

Supplied Accessories

- Remote control with two AA batteries

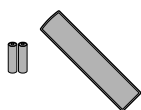

- RF cable

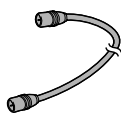

- Audio/Video cables

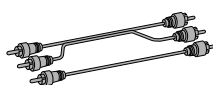

- Owner's Manual

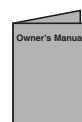

Before you start

Table of contents

Before you start	2	Fast forward / Fast reverse	47
Precautions	2	Skipping TV commercials during playback	47
Table of contents	6	Pause	47
Features	7	Step by step playback	48
Functional overview	8	Slow forward / Slow reverse playback	48
Installing batteries in the remote control	10	Zoom	48
Using a remote control	10	Marker Setup	49
DISPLAY menu	10	Follow Playback during Recording	49
Setting/DISC/CD menu	11	Simultaneous Playback and Recording	50
Connections	13	Search	51
Connection to a TV	13	Title/Chapter search	51
Connection to a cable box or satellite box	14	Track search	52
Connection to an Audio System	15	Time search	52
Getting started	16	Repeat/Random/Program playback	53
Easy DVD recording	16	Repeat playback	53
Channel setting	18	Random playback	53
Getting channels automatically	18	Program playback	54
Adding/deleting channels	19	Slide Show	54
Guide channel setting	20	Selecting a format of audio and video	55
Selecting the TV stereo or SAP	22	Switching subtitles	55
Setting the clock	23	Switching audio soundtrack	55
Auto Clock Setting	23	Switching camera angles	56
Manual Clock Setting	24	Visual Noise Reduction	56
Setting the daylight saving time	25	Editing	57
Selecting the TV aspect ratio	25	Information on disc editing	57
Recording	26	Guide to a title list	57
Information on DVD recording	26	Editing discs in Video mode	57
Information	26	Editing discs in VR mode	57
Recordable disc	26	Editing discs in Video mode	58
Recording speed	26	Deleting titles	58
Restrictions on recording	27	Putting names on titles	59
Information on copy control	27	Setting or clearing chapter markers	60
Making discs playable on other DVD player (Finalize)	27	Editing discs in VR mode (Original)	61
Formatting a disc	28	Deleting titles	61
Choosing the recording format of a blank disc	28	Setting titles to protect	62
Setting Auto Chapter	28	Releasing titles from protecting	63
Reformatting a disc	29	Editing discs in VR mode (Playlist)	64
Recording Audio Select (XP)	30	Deleting titles	64
Basic recording	31	Deleting parts of titles	65
Checking the recording picture and sound quality	31	Putting names on titles	66
One-touch Timer Recording	32	Setting or clearing chapter markers	67
Timer Recording	33	Setting pictures for thumbnails	68
Hints for Timer Recording	36	Dividing a title	69
Timer recording using the VCR Plus+® system	37	Combining titles	70
Settings for an external source	38	Adding titles to a Playlist	71
Connection to an external source	38	Deleting a Playlist	71
Recording from an external source	39	Changing the Setting menu	72
Setting a disc to protect	39	Tour of the Setting menu	72
Finalizing the discs	40	Language setting	73
Auto finalize	41	Display setting	74
Disc playback	42	Audio setting	75
Information on DVD playback	42	Settings for Parental lock level	77
Basic playback	43	Others	79
Playback	43	Troubleshooting	79
Playing back JPEG disc	44	Glossary	83
Playing back discs using the disc menu	45	Language code	84
Playing back discs using the title menu	46	Frequently Asked Questions	84
Cancelling and Recalling the PBC function	46	Specifications	85
Special playback	46	Warranty	87
Resume playback	46		

Before you start

Features

This unit not only plays back DVDs and CDs but also offers features for you to record on DVD discs and edit them after that. The following features are offered with this unit.

Recording

This unit is compatible with both DVD-RW, which is rewritable repeatedly, and DVD-R, which is available for one-time recording only.

Recording up to 8 programs:

You can program the unit to record up to 8 programs within a month in advance. Daily or weekly program recordings are also available.

One-touch Timer Recording:

You can easily set recording time as you prefer. Every time [REC ●] is pressed during recording, the recording time will be increased by 30 minutes up to 4 hours.

The recording automatically stops after set recording time elapses.

The VCR Plus+ system:

You can program the automatic timer recording using the PlusCode programming numbers that are printed in most newspaper TV listings and TV Guide magazine.

Left channel stereo recording:

This unit can record the Left channel monaural sound as Left and Right channel sound automatically (the input from LINE2 only).

[REC MONITOR]:

You can confirm the picture and sound quality for recording of the current recording speed which you set.

If you want to change the recording speed, press [REC SPEED] to set the desired recording mode.

Automatic Chapter marker setting:

You can mark each title of recording with chapter markers as you set in the Setting menu before recording.

Automatic Title menu making (Video mode):

The unit makes title menus automatically when finalizing the disc.

Automatic PLAYLIST making (VR mode):

A Playlist will be prepared from an Original list, so that you can edit titles on a Playlist as you prefer. An Original list is kept as it is.

Automatic finalizing (Video mode):

The unit can finalize discs automatically after finishing all Timer Recordings or when the disc runs out recordable space.

Playback

Theater quality sound at your home:

When connecting the unit to an amplifier or a decoder which is compatible with Dolby Digital or DTS, you can experience the theater-quality sound environment.

Follow Playback during Recording and Simultaneous Playback and Recording:

You can play the already recorded part of the current recording or another title during recording.

Quick search for what you want to watch:

You can easily find the part you want to watch using title, chapter or time search functions.

Start Playback from Original and Playlist (VR mode):

You can play back titles from either the Original list or the Playlist.

JPEG Picture Viewer

Editing

Deleting titles:

You can delete titles which you do not need anymore.

Making your own Playlist (VR mode):

With the Original remains as it is, you can edit titles on Various playlist as you prefer.

Putting names on titles.

Setting pictures for thumbnails.

Setting/clearing chapter markers.

Dividing / Combining titles.

Deleting parts of titles, etc.

Protecting titles (VR mode):

You can prevent accidental editing or title erasing, with this function.

Compatibility

Playback of discs recorded in Video mode on a regular DVD player (Video mode):

Discs recorded in Video mode can be played back on regular DVD players, including computer DVD drives compatible with DVD-Video playback*. You will need to finalize the discs recorded in Video mode to play them back on other DVD players.

* DVD-Video Format (Video mode) is a new format for recording on DVD-RW/R discs that was approved by the DVD Forum in 2000. Adoption of this format is optional for manufactures of DVD playback devices, and there are DVD-Video players, DVD-ROM drives or other DVD playback devices that do not play back DVD-RW/R discs recorded in the DVD-Video Format.

Others









Progressive Scan system

Unlike conventional interlace scanning, the progressive scan system provides less flickering and higher resolution images than the traditional scanning system does.

Symbol in this Owner's Manual

The available functions depend on the type of disc or the recording mode.

To specify disc type or recording mode for each function, we put the following symbols at the beginning of each function.

Symbol	Description
	Available to DVD Video discs
	Available to DVD-RW in Video mode
	Available to DVD-RW in VR mode
	Available to DVD-R discs
	*Available to DVD+RW discs
	*Available to DVD+R discs
	Available to Video CDs
	Available to Audio CDs
	Available to CD-RW/R discs with JPEG files

* Some DVD+RW/+R discs may not be operated properly because the unit conforms to the discs recorded in DVD-RW/-R format.

Before you start

Functional overview

Front Panel

(*) The unit can also be turned on by pressing these buttons.

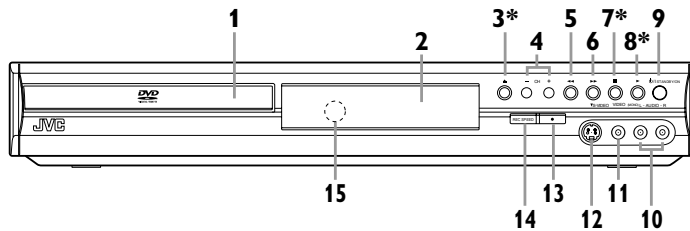

- 1. Disc tray**
Place a disc when it is open.
- 2. Display**
Shows various information and messages.
- 3. OPEN/CLOSE \blacktriangle button***
Press to open or close the disc tray.
- 4. CH + / - buttons**
Press to change the channel up and down.
- 5. REW \blacktriangleleft button**
During playback, press to play back in fast reverse. Or when playback is paused, press to play back in slow reverse.
- 6. FWD \blacktriangleright button**
During playback, press to play back in fast forward. Or when playback is paused, press to play back in slow forward.
- 7. STOP \blacksquare button***
Press to stop playback or recording. Press to stop the preceding Timer Recording in DVD.
- 8. PLAY \blacktriangleright button***
Press to start or resume play.
- 9. STANDBY/ON \odot /I button**
Press to turn on and off the unit.
- 10. AUDIO input jacks (LINE2)**
Use to connect external equipment with standard audio cables.
- 11. VIDEO input jack (LINE2)**
Use to connect external equipment with a standard video cable.
- 12. S-VIDEO input jack (LINE2)**
Use to connect the S-Video output of external equipment with an S-Video cable.
- 13. REC \bullet button**
Press once to start recording. Press repeatedly to start a One-Touch Timer Recording.
- 14. REC SPEED button**
Press to change the recording speed.
- 15. Remote control sensor**
Receive signals from your remote control so that you can control the unit from a distance.

Rear Panel

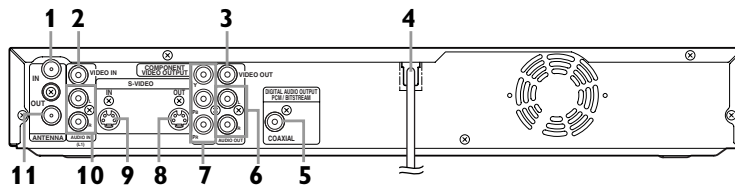

- 1. TV ANTENNA IN jack**
Use to connect an antenna.
- 2. VIDEO IN jack (LINE1)**
Use to connect external equipment with a standard video cable.
- 3. VIDEO OUT jack**
Use to connect a TV monitor, AV receiver or other equipment with a standard video cable.
- 4. AC Power Cord**
Connect to a standard AC outlet to supply power to this unit.
- 5. COAXIAL DIGITAL AUDIO OUTPUT PCM / BITSTREAM jack**
Use to connect an AV receiver, Dolby Digital decoder, DTS decoder or other equipment with a coaxial digital input jack with a digital coaxial cable.
- 6. AUDIO OUT jacks**
Use to connect a TV monitor, AV receiver or other equipment with standard audio cables.
- 7. COMPONENT VIDEO OUTPUT jacks**
Use to connect a TV monitor with component video inputs with component video cables.
- 8. S-VIDEO OUT jack**
Use to connect the S-Video input of a TV monitor, AV receiver or other equipment with an S-Video cable.
- 9. S-VIDEO IN jack (LINE1)**
Use to connect the S-Video output of external equipment with an S-Video cable.
- 10. AUDIO IN jacks (LINE1)**
Use to connect external equipment with standard audio cables.
- 11. TV ANTENNA OUT jack**
Use to connect an antenna cable to pass the signal from the TV ANTENNA IN to your TV monitor.

Note: Do not touch the inner pins of the jacks on the rear panel. Electrostatic discharge may cause permanent damage to the unit.

Functional overview (cont'd)

Remote Control

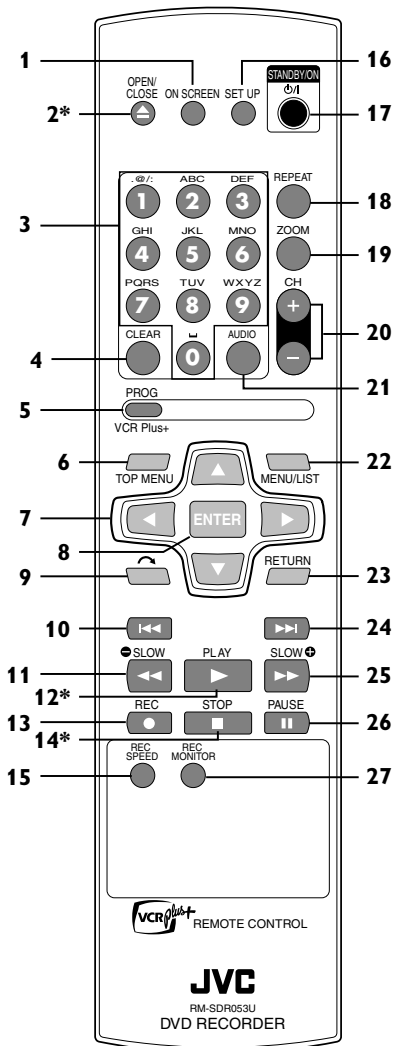

(*) The unit can also be turned on by pressing these buttons.

1. **ON SCREEN** button
Press to display the on-screen menu.
2. **OPEN/CLOSE** ▲ button*
Press to open or close the disc tray.
3. **Number buttons**
Press to select channel numbers. Press to select a title / chapter / track on display.
4. **CLEAR** button
Press to clear the password entered, to cancel the programming for CD, to clear the highlighted marker number in the marker setup mode or to clear the program once entered in the Timer Recording setting mode, etc.
5. **PROG/VCR Plus+** button
Press once to display the VCR Plus+ setting window. Press twice to display the Timer Programming list.
6. **TOP MENU** button
Press to display the top menu.
7. **Cursor** ▲ / ▼ / ◀ / ▶ buttons
Press to select items or settings.
8. **ENTER** button
Press to confirm or select menu items.
9. **CM SKIP** button
During playback, press to skip to the 30 second advanced point.
10. **SKIP** button
During playback, press to skip to the previous chapter or track. Or when playback is paused, press to play back in reverse step by step.
11. **SLOW** / **REW** button
During playback, press to play back in fast reverse. Or when playback is paused, press to play back in slow reverse.
12. **PLAY** button*
Press to start or resume playback.
13. **REC** button
Press once to start a recording. Press repeatedly to start a One-Touch Timer Recording.
14. **STOP** button*
Press to stop playback or recording.
15. **REC SPEED** button
Press to change the recording speed.
16. **SET UP** button
Press to display the Setting menu.
17. **STANDBY/ON** button
Press to turn on and off the unit.
18. **REPEAT** button
Press to display the repeat setting menu.
19. **ZOOM** button
During playback, press to enlarge the picture on the screen.
20. **CH +/-** buttons
Press to change the channel up and down.
21. **AUDIO** button
Press to display the audio menu during playback.
22. **MENU/LIST** button
Press to display the Disc menu. Press to change ORIGINAL and PLAYLIST on the TV screen. (VR mode only)
23. **RETURN** button
Press to return to the previously displayed menu screen.
24. **SKIP** button
During playback, press to skip to the next chapter or track. Or when playback is paused, press to play back in forward step by step.
25. **SLOW** / **FWD** button
During playback, press to play back in fast forward. Or when playback is paused, press to play back in slow forward.
26. **PAUSE** button
Press to pause playback or recording.
27. **REC MONITOR** button
Press to check the video and audio signals for recording.

Before you start

Functional overview (cont'd)

Installing batteries in the remote control

Install two “AA” size batteries (supplied), matching their polarity to those indicated inside battery compartment of the remote control.



Note:

Incorrect use of batteries can result in hazards such as leakage and bursting. Please follow the instruction below:

- Do not mix new and old batteries together.
- Do not use different kinds of batteries together. Although they may look similar, different batteries may have different voltages.
- Make sure that the plus and minus ends of each battery match the indications in the battery compartment.
- Remove batteries from equipment that is not going to be used for a month or more.
- When disposing used batteries, please comply with governmental regulations or public rules for environmental protection that apply in your country or area.
- Do not recharge, short-circuit, heat, burn or disassemble batteries.

Using a remote control

Keep in mind the following when using the remote control:

- Make sure that there is no obstacle between the remote control and the remote sensor of the unit.
- Remote operation may become unreliable if strong sunlight or fluorescent light is on the remote sensor of the unit.
- Remote control for different devices can interfere with each other. Avoid using remote control for other equipment located close to the unit.
- Replace the batteries when you notice a fall-off of the operating range of the remote control.
- The maximum operable ranges from the unit are as follows.
 - **Beeline:** approx. 23 feet (7m)
 - **Either side of the center:** approx. 16 feet (5m) within 30°
 - **Above:** approx. 16 feet (5m) within 15°
 - **Below:** approx. 10 feet (3m) within 30°

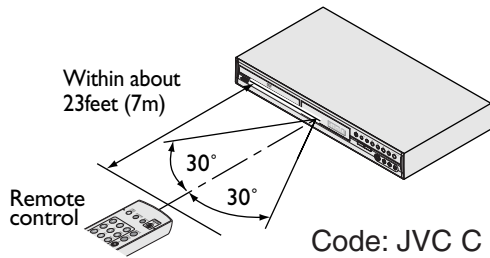

DISPLAY menu

Press **[ON SCREEN]** to call up the display menu. This menu will give you the information on the disc. Some operations are available while disc is played back.

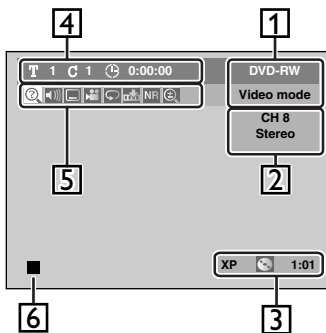

1. Indicates a disc type and a format mode.
Note: In some descriptions on this manual, only one disc type is indicated as an example.
2. Indicates a current channel number and an audio status of the program.
3. Indicates a recording mode and possible recording time left.
4. Indicates a title number, chapter number and the time elapsed of disc play.

5. Each icon means:

- : Search
- : Audio
- : Subtitle
- : Angle (except VR mode)
- : Repeat
- : Marker
- : Noise Reduction
- : Zoom

6. Indicates current disc status.

Note:

- This is an example screen only for explanation. Displayed items will change depending on the actual mode.
- DISPLAY function is not available when no disc is inserted.

Guide to Displays on-screen menu

This unit uses the following on-screen menu for most operations: Easy Setting Menu, Advanced Setting Menu, Title list, Playlist, Original and DISPLAY menu. They allow you to change the playback status of the disc during playback. The DISPLAY menu also gives you information on the playback status of the disc.

Setting/DISC/CD menu

In stop mode, press **[SET UP]** to display Easy Setting Menu or Advanced Setting Menu. Choose either Menu using **[▲ / ▼]**, then press **[ENTER]** to display it.

These menus allow you to perform all main functions and change setting for them.

Easy Setting Menu and Advanced Setting Menu are available. Easy Setting Menu consists of those frequently needed. You can make all required setting using Advanced Setting Menu. Items with  mark can be set in both menus.

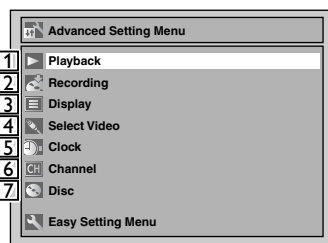
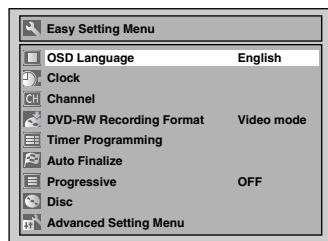

1. Playback:

To set up the unit to play back discs as you prefer.

2. Recording:

To set up the unit to record on discs.

3. Display:

To set up the OSD screen and the front display of the unit as you prefer.

4. Select Video:

To choose a line input to record on DVD discs from other video equipment.

5. Clock:

To set up the clock of the unit.

6. Channel:

To adjust the channel setting of the unit as you prefer.

7. Disc / CD Playback Mode:

"Disc" is available only when a DVD-RW/R disc is inserted into the unit. When a DVD-Video disc (commercially available), a new DVD-R disc or a finalized DVD-R disc is inserted into the unit, you cannot select "Disc".

"CD Playback Mode" is available only when an Audio CD disc, Video CD or a CD-RW/R disc with JPEG files is inserted into the unit.

<DVD-R, DVD-RW (Video mode)>

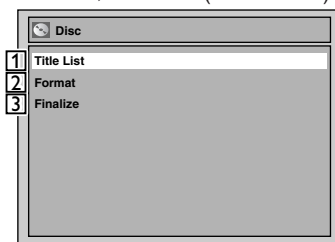

<DVD-RW (VR mode)>

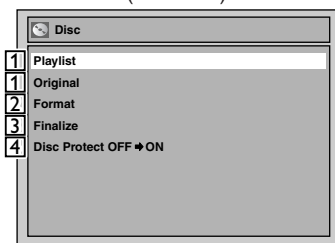

<Audio CD, Video CD, JPEG>

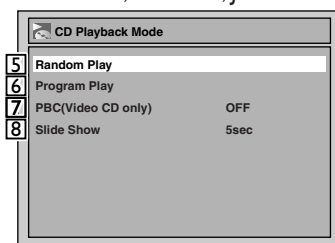

1. Title List / Playlist / Original:

Turns on a title list, playlist or Original, which shows the recorded titles on the disc.

2. Format (DVD-RW only):

Allows you to erase all of the recorded content on the disc.

The disc will be completely blank.

- Erased content cannot be retrieved.

- A DVD-RW disc formatted in Video mode with this unit can not be used on other DVD recorders for recording.

- If you want to use a disc formatted with this unit on another DVD recorder, you have to re-format the disc on that recorder.

3. Finalize:

Allows you to finalize a disc with titles recorded on this unit only.

4. Disc Protect (VR mode only):

Allows you to protect a disc from accidental editing or recording.

5. Random Play:

To activate the random playback.

6. Program Play (Audio CD and Video CD only):

To activate the programmed playback.

7. PBC (Video CD only):

To switch the PBC (Play Back Control) on or off.

8. Slide Show (JPEG only):

To change the length of the JPEG picture display on the TV screen.

Note:

- This is an example screen only for explanation. Displayed items will change depending on the actual mode.

Before you start

Functional overview (cont'd)

Front Panel Display Guide

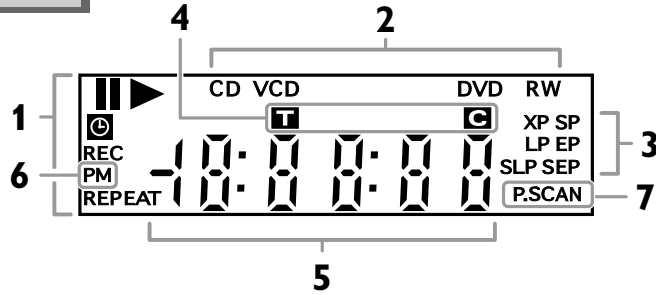

1. Current status of the unit

- ||** : Appears when a disc play is paused.
- ▶** : Appears when playing back a disc.
- ⌚** : Appears when the timer programming or OTR has been set and is proceeding. Flashes when all Timer Recordings have been finished, or when a program cannot be performed with some reasons.
- REC** : Appears during recording process. Flashes when a recording pauses.
- REPEAT** : Appears during repeat playback (disc playback only).

2. Disc type and Current status of the unit

- CD** : Appears when an audio CD or a disc with JPEG files is on the disc tray.
- VCD** : Appears when a Video CD is on the disc tray.
- DVD** : Appears when a DVD disc is on the disc tray.
- DVD R** : Appears when a DVD-R disc is on the disc tray.
- DVD RW** : Appears when a DVD-RW disc is on the disc tray.

3. Recording speed

Indicates the recording speed of the disc.

4. Title/Track and Chapter mark

- T** : Appears when indicating a title/track number.
- C** : Appears when indicating a chapter number.

5. Displays the following

- Played-back time / remaining time
- Current title / chapter / track number
- Recording time
- Clock
- Channel number
- Remaining time for a one-touch Timer Recording

6. PM : Appears in the afternoon with the clock display.

7. P.SCAN :

Appears when the progressive scan system is activated.

Display message



Appears when the unit is turned on.



Appears when the disc tray is closing.



Appears when the unit is turned off.



Appears when a disc is loaded on the disc tray.



Appears when the disc tray is opening.

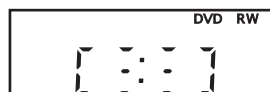

Appears when data is being recorded on a disc.

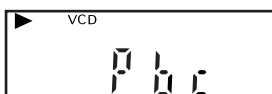

Appears when the PBC function is activated (Video CD playback only. Refer to page 45).

Connections

Connection to a TV

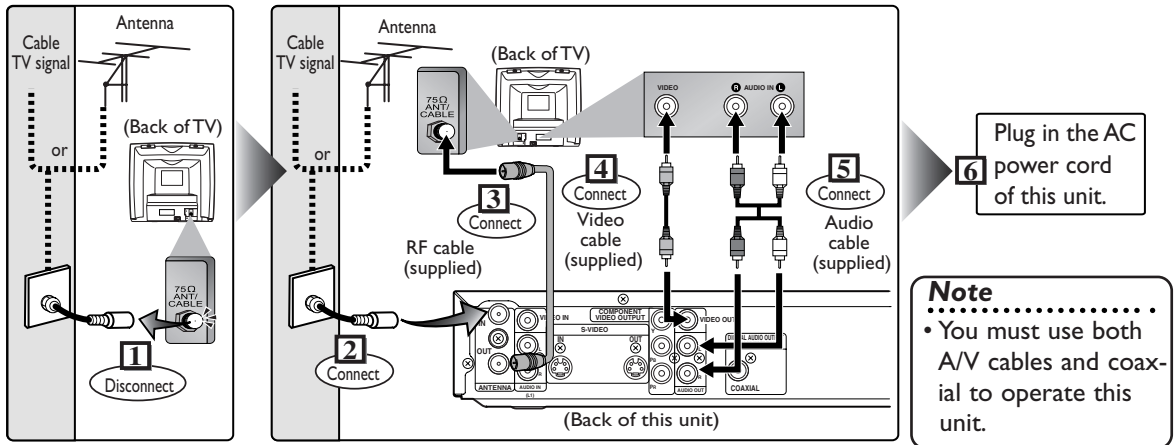

Choose one of the following connections, depending on the capabilities of the equipment you possess.

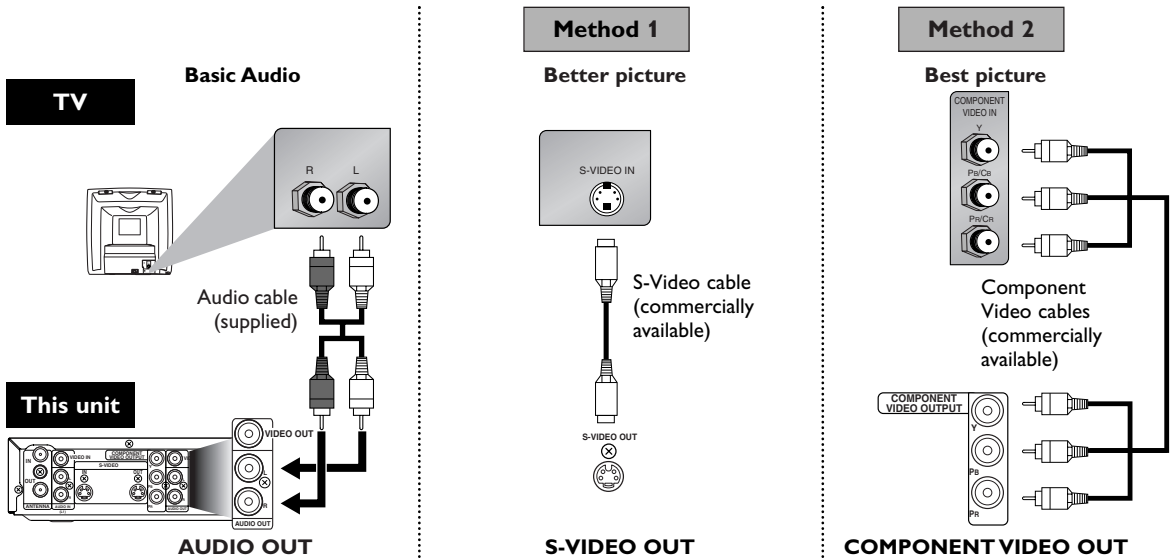

After you have completed connections

- Switch the input selector on your TV to an appropriate external input channel (usually near channel 0). Press a button on the TV's original remote control that selects an external input channel until the DVD recorder's picture appears. Check your TV owner's manual for details.

Input Mode Names for Common TV Brands (Example)

Admiral	AUX	Panasonic	TV/VIDEO
Curtis Mathis	LINE1, LINE2, 00, 90, 91, 92, 93	RCA	INPUT, TV/VCR, 00, 90, 91, 92, 93
GE	INPUT, TV/VCR, 00, 90, 91, 92, 93	Samsung	TV/VIDEO
Hitachi	INPUT, AUX	Sanyo	VIDEO
JVC	VIDEO, VIDEO1, VIDEO2, VIDEO3	Sharp	00
Kenwood	AUX	Sony	VIDEO1, VIDEO2, VIDEO3
LXI-Series	00	Toshiba	TV/GAME
Magnavox	AUX CHANNEL	Zenith	00

Note

- Connect this unit directly to the TV. If the A/V cables are connected to a VCR, pictures may be distorted due to the copy protection system.

Connections

Connection to a TV (cont'd)

If your TV is compatible with Progressive Scan (525p / 480p) and you want to enjoy that high quality picture;

You must select the connection Method 2 on page 13 and Progressive Scan mode. To set the mode, press **[SET UP]** and set "Progressive" to "ON" on the Easy Setting Menu, or on the "Playback" sub menu of the Advanced Setting Menu. Then press **[ENTER]**.

"PSCAN" will appear on the display of this unit.

If your TV is not compatible with Progressive Scan;

Use this unit in Interlace mode. Make sure that no "PSCAN" is on the display of this unit. If not, press **[SET UP]** and set "Progressive" to "OFF" on the Easy Setting Menu, or on the "Playback" sub menu of the Advanced Setting Menu. Then press **[ENTER]**. "PSCAN" on the display of this unit will disappear.

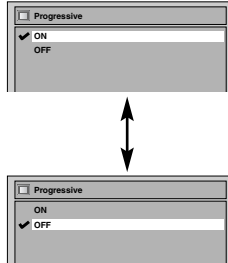

Connection to a cable box or satellite box

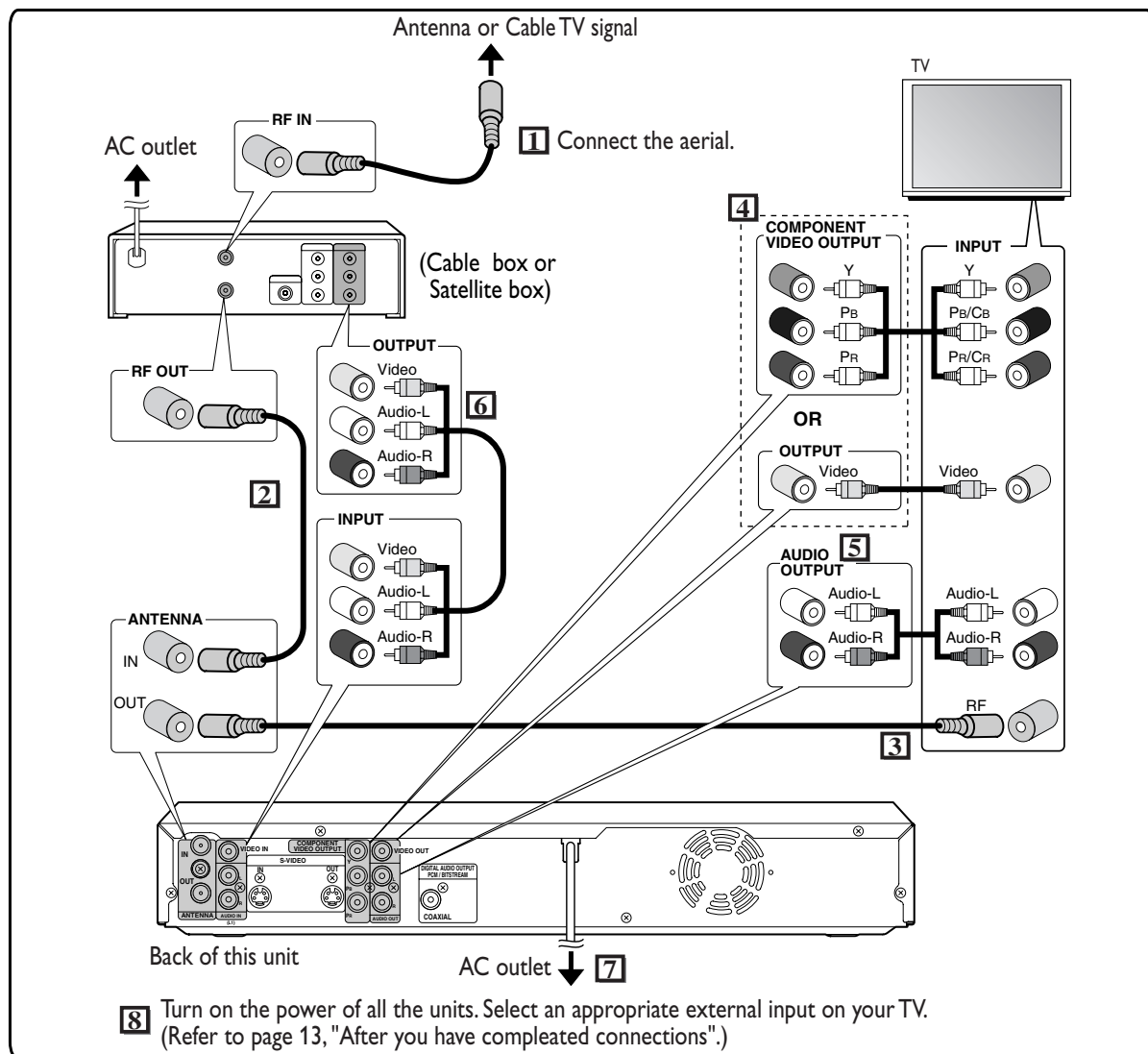

Note to the Cable TV System Installer :

This reminder is provided to call the Cable TV system installer's attention to Article 820-40 of the National Electrical Code, which provides guidelines for proper grounding - in particular, specifying that the cable ground shall be connected to the grounding system of the building, as close to the point of cable entry as possible.

Connections

Connection to an Audio System

- When you change the connections, all devices should be turned off.
- Refer to the operation manual accompanying external devices for more information.

Method 1

Stereo system

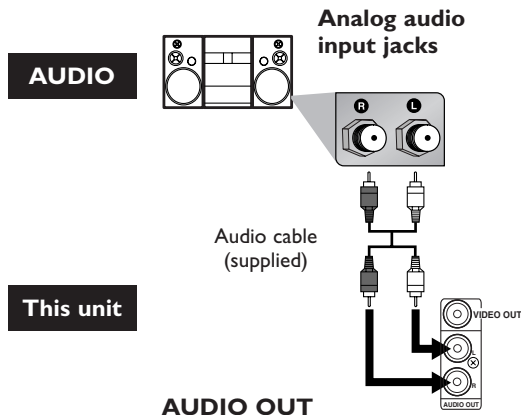

Method 2

Dolby Digital decoder, DTS decoder, MD deck or DAT deck

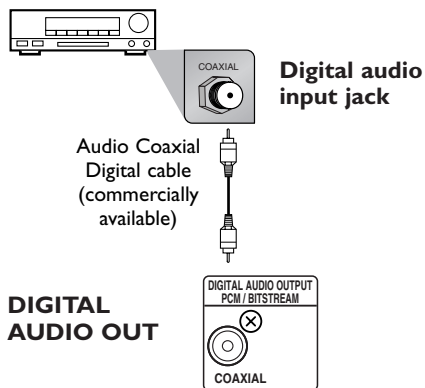

- The playback soundtrack selection is done in DISC menu available thru **[TOP MENU]** or **[MENU/LIST]** buttons. DIGITAL OUT settings must be done correctly to allow selected soundtrack to be played correctly.

Connection	Setting	SET UP>Advanced Setting Menu >Playback >Digital Out >		
		PCM	Dolby Digital	DTS
If output is Dolby Digital encoded audio, connect to a Dolby Digital decoder.		-	Stream	OFF
If output is DTS encoded audio, connect to the DTS decoder.		-	PCM	ON
If output is encoded audio for both Dolby Digital and DTS, connect to the decoder which encodes multiple audio sources.		-	Stream	ON
Connecting to an MD deck or DAT deck.		-	PCM	OFF
If not connected to any external devices.		-	PCM	OFF

*To complete these settings, refer to pages 75-77.

Note

- By connecting this unit to a Multi-channel Dolby Digital decoder, you can enjoy high-quality Dolby Digital 5.1 channel surround sound as heard in the movie theaters.
- The audio source on a disc in a Dolby Digital 5.1 channel surround format cannot be recorded as digital sound by an MD or DAT deck.
- By connecting this unit to the DTS decoder, you can enjoy 5.1 channel Surround System which reproduces the original sound as truthfully as possible. 5.1 channel Surround System is developed by the Digital Theater System Inc.
- Playing back a DVD using incorrect settings may generate noise distortion and may also damage the speakers.

Getting started

Easy DVD recording

The following will help you to understand easily how to record to DVD discs.

Note:

Make sure batteries are in the remote control and you have connected this unit and the TV correctly.

Step 1: Choose a disc type

There are several types of recordable DVD discs to choose from. Choose a recordable DVD disc type based on your playback/recording/editing needs. See "DVD disc types" at the bottom of this page for more information on the differences among various compatible media.

This DVD recorder can record on the following type of discs.

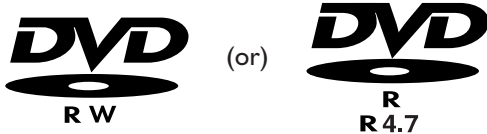

For example, when you want to record repeatedly on the same disc or when you want to edit the disc after recording, select the rewritable DVD-RW type disc.

When you want to save recordings without any alteration, a non-rewritable DVD-R can be your choice.

Step 2: Insert a blank disc

Remote Control

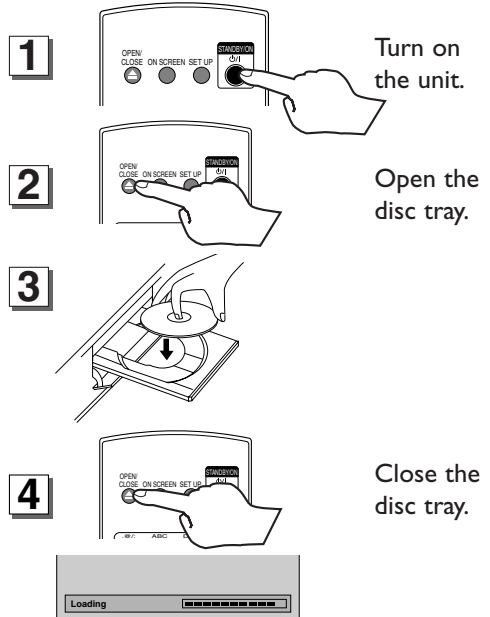

This operation may take a while to be recognized.

DVD disc types

☆☆☆ : Most suitable. ☆☆☆ : Can be used. ☆ : Some functions are limited. — : Cannot be used.

You want to	DVD-RW VR	DVD-RW Video	DVD-R
Record TV programs	☆☆☆	☆☆☆	☆☆
Reuse by deleting unwanted contents	☆☆☆	☆☆	—
Edit recorded contents	☆☆☆	☆	☆
Edit/Record from connected equipment	☆☆☆	☆☆☆	☆☆☆
Copy discs for distribution	☆☆ ^{*1}	☆☆☆	☆☆☆
Play on other DVD equipment	☆☆ ^{*1}	☆☆☆	☆☆☆

Features	DVD-RW VR	DVD-RW Video	DVD-R
Recording			
Rewritable?	Yes	Yes	No
Can create chapters at fixed intervals (auto.)	Yes	Yes	Yes
Can create chapters wherever you like (manual)	Yes	No	No
Can record 16:9 size pictures	Yes	Yes	Yes
Can record Copy-Once programs	Yes	No	No
Editing			
Can perform basic edit functions	Yes	Yes	Yes
Can perform advanced edit functions (Playlist edit)	Yes	No	No

^{*1} DVD-RW (VR mode) can only be played on DVD equipment that is VR compatible.

Note:
For details of the above functions and implied restrictions, see the explanations inside the manual.

Format the disc

When inserting a disc that has already been recorded on, you can delete those contents by formatting that disc.

Formatting is only necessary to prepare disc previously recorded on for recording.

Details are on pages 28-29.

When you format a disc, the entire contents on that disc will be erased.

- The unit automatically starts initializing when a brand new disc is inserted.

Getting started

Easy DVD recording (Cont'd)

Step 3: Select the Recording speed

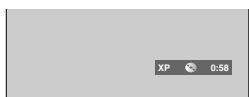

Step 4: Select the desired channel

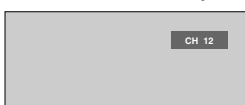
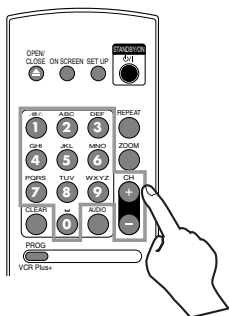

Step 5: Record to DVD discs

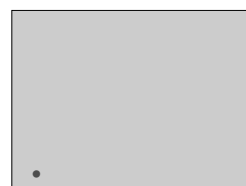
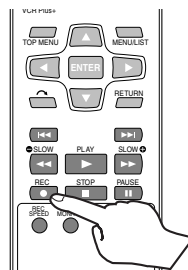

Hint 1: Play the recorded contents

You can select the title you want to play back from a displayed menu, and immediately start to play back. Recorded contents are easily accessible, with simple procedure of choosing a title on a chapter on the menu screen.

What are titles and chapters?

The contents of a DVD disc are generally divided into titles. Titles may be further divided into chapters.

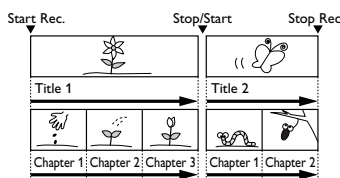

Hint 2: Edit the recorded disc

You will find editing discs is easy. This unit offers convenient editing functions which are possible only with DVD-RW/R discs.

Title list offers the following editing functions.

- Putting names on titles
- Setting pictures for thumbnails
- Setting/clearing chapter markers
- Deleting parts of titles or scenes

(Possible editing functions depend on the recording format and editing method.)

Original and Playlist (VR mode)

You can edit the contents on a Playlist without changing the original recordings. A Playlist does not take up much disc space.

What "Original" or "Playlist" is for?

Throughout this manual, you will find *Original* and *Playlist* to refer to the original content and the edited version.

- **Original** content refers to what's originally recorded on the disc.
- **Playlist** content refers to the edited version of the original content.

Finalizing a Disc

- You need to record in video mode and finalize the disc to play it back on other players.
- Once you finalize a disc recorded in video mode, you cannot record or edit any information on the disc.
- Discs recorded in VR mode can still be edited after finalization.

Step 6: Stop the Record

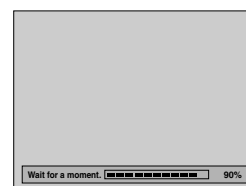
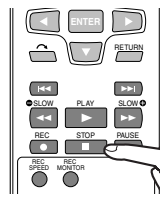

(Appears only in the VR mode)

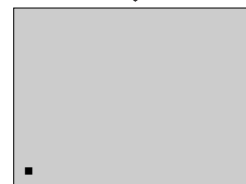

This operation may take a while to be completed.

Getting started

Channel setting

Right after the purchase of the unit and whenever you move to a new area, we recommend to program available channels in your area using “Auto Preset” in the Channel Preset of the Setting menu.

Getting channels automatically



1

Press [STANDBY/ON].

2

Turn on the TV. Select the input to which the unit is connected.

Refer to the table on page 13.

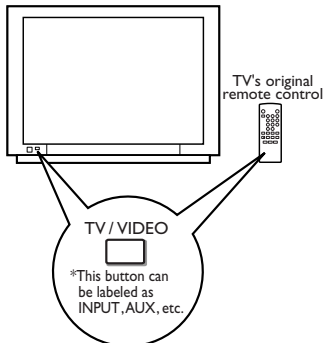

3

Press [SET UP].

Easy Setting Menu or Advanced Setting Menu will appear.

4

Using [\blacktriangle / \blacktriangledown], select “Channel”. Press [ENTER].

Channel menu will appear.

5

Using [\blacktriangle / \blacktriangledown], select “Auto Preset”. Press [ENTER].

The unit will start getting channels available in your area.

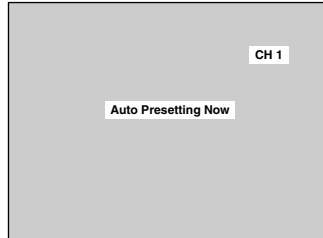

Wait for several minutes to finish channel scanning.

6

Press [SET UP] to exit.

• [CH + / -] will switch among the memorized channels.

3

6

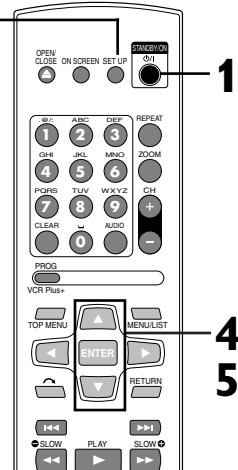

To select a channel

You can select a channel by directly entering channel number using the **Number buttons** on the remote control.

Notes for using the Number buttons:

- When selecting cable channels which are larger than 99, enter channel numbers as a three-digit number. (For example: 117, press [1], [1], [7].)
- You must precede single-digit channel numbers with a zero (For example: 02, 03, 04 and so on).
- You can select the line input mode (“L1” or “L2”). To select “L1” by pressing [0], [0], [1]. To select “L2” by pressing [0], [0], [2]. Details are on page 39.

Note

- You cannot change the channel while one of the functions on the unit is in the recording, OTR or Timer Recording mode.
 - If the auto presetting is cancelled during presetting, some of the channels not yet preset may not be received.
 - The selection will depend on how you receive the TV channels.
- To cancel the auto presetting during scanning:**
Press [RETURN] or [SET UP] to cancel.

Adding/deleting channels



The channels you no longer receive or seldom watch can be deleted from the memory. You can also add channels manually into memory.

1

Press **[SET UP]**.

Easy Setting Menu or Advanced Setting Menu will appear.

2

Using **[▲ / ▼]**, select **“Channel”**. Press **[ENTER]**.

Channel menu will appear.

3

Using **[▲ / ▼]**, select **“Manual Preset”**. Press **[ENTER]**.

Manual Preset menu will appear.

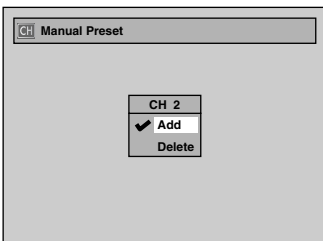

4

Select the channel number to add or delete.

Press **[◀]** or **[CH -]** to move to a smaller channel number.

Press **[▶]** or **[CH +]** to move to a larger channel number.

- Use **[◀ / ▶]** to move through the channels one by one, including the ones not in the channel memory, while use **[CH + / -]** to move through the channels only in the channel memory.

Press **the Number buttons** to select a channel number directly.

5

Using **[▲ / ▼]**, select **“Add”** or **“Delete”**. Press **[ENTER]**.

The channel number will be added or deleted from the channel memory. Then, the next channel number will appear so that you can continue adding or deleting channels.

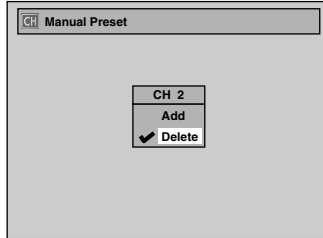

6

Press **[SET UP]** to exit.

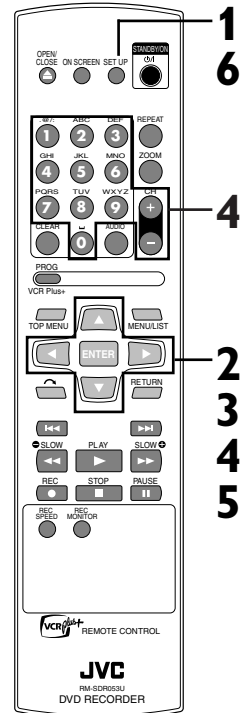

Getting started

Channel setting (cont'd)

Guide channel setting

First, fill in the boxes on this page:

1.
Write your local channel numbers in “TV Channel” column, which you can receive in your area by channel preset.

2.
Write local TV stations corresponding TV Channel in “Call letters” column, and write guide channel numbers corresponding call letters in “Guide Channel” column, consulting your TV guide magazine or the TV listings of your local newspaper.

Remember:

If your cable box or satellite box is connected as in “Connection to a cable box or satellite box” on page 14, TV Channel number must be channel 3 or 4 for every guide channel number.

Now, compare the channel numbers you have written in the Guide Channel and TV Channel columns. You must set all of these channel numbers that don't match using the following procedure before you program the automatic timer recording using the VCR Plus+ system.

- This setting only needs to be set once, but must be done again if you have moved to a different area and channel numbers have been changed.

Channel Line-Up Chart

Call letters (Local TV station)	Guide Channel (Guide channel number)	TV Channel (Local channel number)

1
Press [SET UP].
Easy Setting Menu or Advanced Setting Menu will appear.
If Advanced Setting Menu is displayed, proceed to step 3.

4
Using [▲ / ▼], select “Guide Channel Setting”. Press [ENTER].
Guide Channel Setting list will appear.

2
Using [▲ / ▼], select “Advanced Setting Menu”. Press [ENTER].
Advanced Setting Menu will appear.

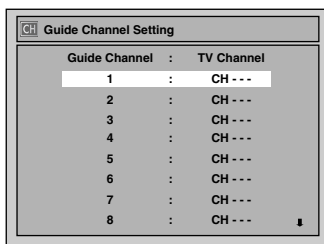

3
Using [▲ / ▼], select “Channel”. Press [ENTER].
Channel menu will appear.

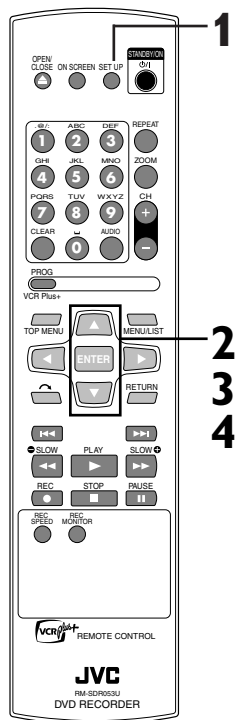

Getting started

Channel setting (cont'd)

5

Assign channel numbers to the guide channels as necessary.

Look in your TV guide to see which channel numbers should be assigned to which guide channels.

1.

Using [▲ / ▼], select a channel number. Press [ENTER].

A cursor will move to a TV channel column.

If the channel you wish to set is not on the screen, press [◀ / ▶] to change the displayed page until you reach the correct page.

2.

Using [◀ / ▶], select an external input (L) or CATV/TV channel (CH).

3.

Using the Number buttons or [▲ / ▼], enter a TV channel number, then press [ENTER].

The channel number is assigned.

The channel number is assigned.

Repeat 1-3 above to assign more channels.

6

Press [SET UP] to exit.

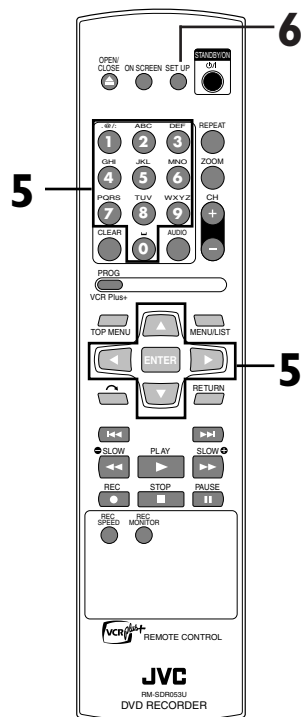

Note

- To erase a TV channel, press [◀] at step 5-3.

Getting started

Selecting the TV stereo or SAP

You can select an audio channel to output from TV.

1

Press **[SET UP]**.

Easy Setting Menu or Advanced Setting Menu will appear. If Advanced Setting Menu is displayed, proceed to step 3.

2

Using **[▲ / ▼]**, select “Advanced Setting Menu”.

Press **[ENTER]**.

Advanced Setting Menu will appear.

3

Using **[▲ / ▼]**, select “Channel”. Press **[ENTER]**.

Channel menu will appear.

4

Using **[▲ / ▼]**, select “TV Audio Select”. Press **[ENTER]**.

Option window will appear.

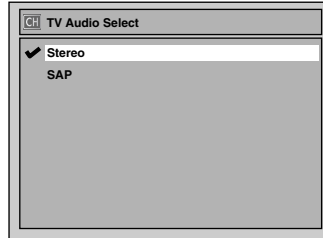

The default is set as “Stereo”.

5

Using **[▲ / ▼]**, select “Stereo” or “SAP”. Press **[ENTER]**.

Stereo:

Outputs main-audio.

SAP (Secondary Audio Program):

Outputs sub-audio.

Refer to the item in “Glossary” on page 83 for more information.

6

Press **[SET UP]** to exit.

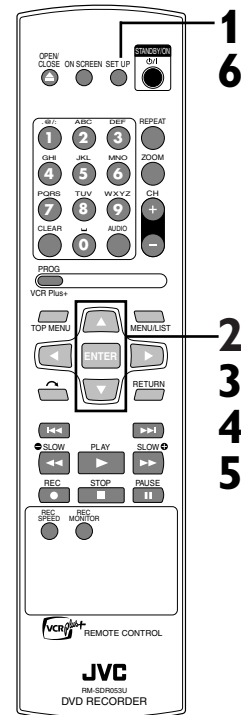

Notes on TV channel audio

- If you want to record a TV program available in second audio or stereo on a DVD-RW/R, you have to select either Stereo or SAP in the Channel Preset screen beforehand. Refer to the following table to check an appropriate setting.

Selected audio	Broadcast audio	Disc recording	Audio output
Stereo	STEREO+SAP	STEREO	STEREO
	STEREO	STEREO	STEREO
	MONO+SAP	MONO	MONO
	MONO	MONO	MONO
SAP	STEREO+SAP	SAP	SAP
	STEREO	STEREO	STEREO
	MONO+SAP	SAP	SAP
	MONO	MONO	MONO

- You can only play back the disc in second audio if a TV program is available in second audio and you set “TV Audio Select” to “SAP”.

Getting started

Setting the clock

Set the clock before you try the Timer Recording. If Public Broadcasting Service (PBS) is available in your area, follow the Auto Clock Setting below. If not, follow the Manual Clock Setting on page 24.

Auto Clock Setting

Make sure:

- The antenna/cable TV connections are correct.
- If this unit is connected to a Cable Box or Satellite Box, select the local PBS station to set the clock automatically.

1 Press [SET UP].
Easy Setting Menu or Advanced Setting Menu will appear.

If Advanced Setting Menu is displayed, proceed to step 3.

2 Using [▲ / ▼], select "Advanced Setting Menu".
Press [ENTER].

Advanced Setting Menu will appear.

3 Using [▲ / ▼], select "Clock".
Press [ENTER].
Clock menu will appear.

4 Using [▲ / ▼], select "Auto Clock Setting". Press [ENTER].
Option window will appear.

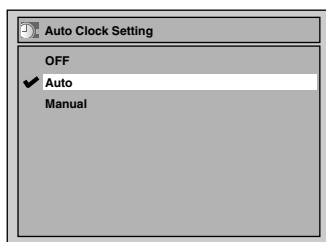

The default setting is "Auto".

5

• If you do not know the PBS channel number in your area:

Using [▲ / ▼], select "Auto". Press [ENTER].

The setting will be activated.

• If you know the PBS channel number in your area:

Using [▲ / ▼], select "Manual". Press [ENTER].

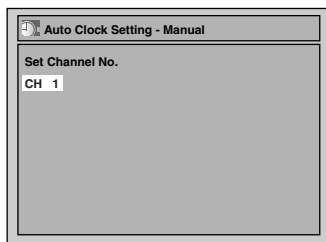

Using the Number buttons or [▲ / ▼], enter the PBS channel number. Press [ENTER].

The setting will be activated.

• If you want to set the clock manually and cancel the auto clock setting:
Using [▲ / ▼], select "OFF".
Press [ENTER].

The auto clock setting will be canceled.

6 Press [SET UP] to exit.

7 Press [STANDBY/ON ⏻/I] to turn off the unit.

This unit will search for the clock time only when the power is off. Leave it off for several minutes to give this unit time to set the clock on the display of the front panel.

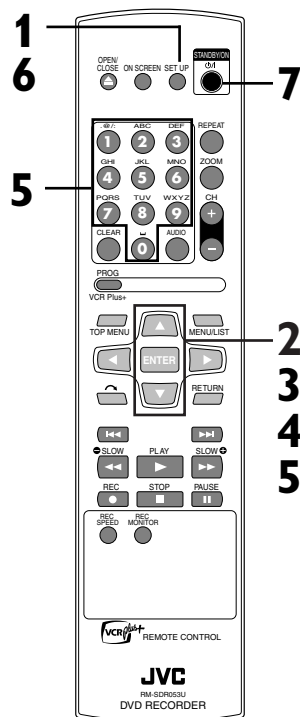

Note

- The clock may set itself automatically after you connect the antenna/cable signal to this unit and plug in the power cord. In this case, the current time will appear on the front panel display.
- If the current time is not displayed or the displayed clock time is not correct, set the clock manually.

Getting started

Setting the clock (cont'd)

Manual Clock Setting

1

Press [SET UP].

Easy Setting Menu or Advanced Setting Menu will appear.

2

Using [▲ / ▼], select “Clock”. Press [ENTER].

When entering from Advanced Setting Menu, Clock menu will appear.

3

When entering from Advanced Setting Menu, using [▲ / ▼], select “Clock Setting”. Press [ENTER].

A clock setting window will appear.

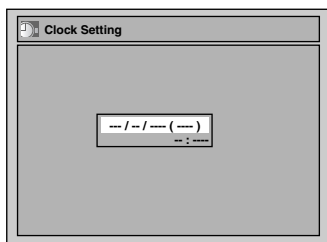

Press [ENTER] again.

Default date will appear.

4

Using [▲ / ▼], enter the date (month / day / year).

Press [◀ / ▶] to move the cursor.

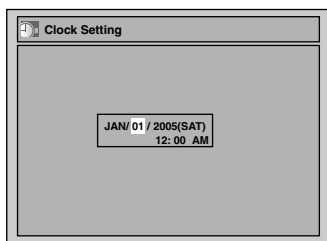

5

Using [▲ / ▼], enter the time (hour / minute).

Press [◀ / ▶] to move the cursor.

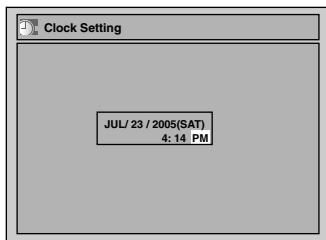

6

Press [▲ / ▼] to select AM or PM. Press [ENTER].

Clock menu will appear, then the settings will be activated.

Although seconds are not displayed, they will be counted from zero.

7

Press [SET UP] to exit.

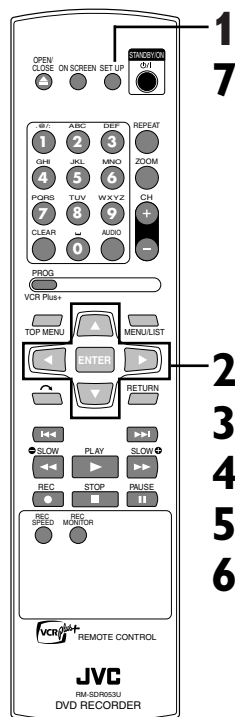

Note

- Your clock setting will be lost if either there is a power failure or this unit has been unplugged for more than 30 seconds.

Getting started

Setting the clock (cont'd)

Setting the daylight saving time

When Daylight Saving Time is ON, the clock will automatically move forward one hour on the first Sunday in April and move back one hour on the last Sunday in October.

1

Press [SET UP].

Easy Setting Menu or Advanced Setting Menu will appear. If Advanced Setting Menu is displayed, proceed to step 3.

2

Using [▲ / ▼], select "Advanced Setting Menu". Press [ENTER].

Advanced Setting Menu will appear.

3

Using [▲ / ▼], select "Clock". Press [ENTER].

Clock menu will appear.

4

Using [▲ / ▼], select "Daylight Saving Time". Press [ENTER].

Option window will appear.

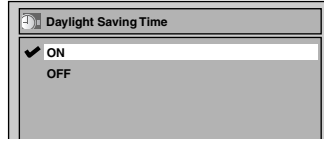

5

Using [▲ / ▼], select "ON" or "OFF". Press [ENTER].

Choose "ON" if you are currently observing the daylight saving time.

6

Press [SET UP] to exit.

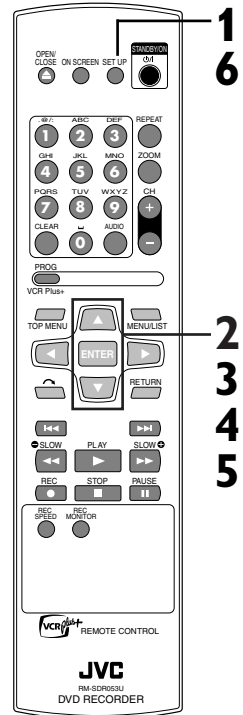

Selecting the TV aspect ratio

You can select the TV aspect ratio to match the formats of what you are playing back on the unit and your TV screen (4:3 standard or 16:9 widescreen TV). The default is set as "4:3 Letter Box".

1

Press [SET UP].

Easy Setting Menu or Advanced Setting Menu will appear. If Advanced Setting Menu is displayed, proceed to step 3.

2

Using [▲ / ▼], select "Advanced Setting Menu". Press [ENTER].

Advanced Setting Menu will appear.

3

Using [▲ / ▼], select "Playback". Press [ENTER].

Playback menu will appear.

4

Using [▲ / ▼], select "TV Aspect". Press [ENTER].

Option window will appear.

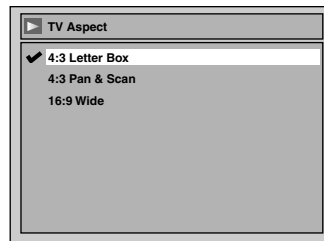

Refer to the Note on this page.

5

Using [▲ / ▼], select a desired option. Press [ENTER].

6

Press [SET UP] to exit.

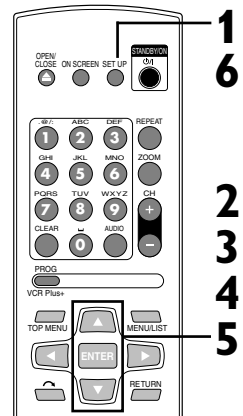

Note

If you have a standard TV:

Select "4:3 Letter Box" for full length picture with black bars on the top and bottom of the screen. Select "4:3 Pan & Scan" for a full height picture with both sides trimmed.



If you have a widescreen TV: Select "16:9 Wide".

Recording

Information on DVD recording

Information

This unit can record on DVD-R and DVD-RW discs. DVD-R discs allow you to record programs only once, and the recorded contents cannot be erased. DVD-RW discs allow you to record programs repeatedly, and the recorded contents can be erased. You can record programs on DVD-R discs only in Video mode, while recording format for DVD-RW discs can be either Video mode or VR mode.

Logo	Attributes
	• 8cm/12cm, single-sided, single layer disc
DVD-RW	• Approx. max. recording time (SEP mode): 600 minutes (4.7GB) (for 12cm) 180 minutes (1.4GB) (for 8cm)
	
DVD-R	

Recordable disc

- Discs that should be used with this recorder:
DVD-RW 2x or 4x
DVD-R 4x or 8x
- Discs that were tested and proven as compatible with this recorder:
Maxell DVD-R
TDK DVD-RW 2x
MITSUBISHI DVD-R 8x
JVC DVD-RW 4x





About Video mode and VR (Video Recording) mode

Video mode is the same recording format as DVD-Video discs purchased locally and played back on most DVD players.

To play back the disc on other DVD players, you will need to finalize the disc (Refer to page 40). Before finalization, you can record additionally or edit disc with this unit.

VR (Video Recording) mode is a basic recording format for DVD-RW. You can edit, record and delete repeatedly.

DVD players with  are capable of playing DVD-RW recorded in VR mode.

Disc type	Disc format	Functions
	Video mode 	Playback, limited recording, limited editing
DVD-RW	VR mode 	Playback, recording, Original/Playlist editing
	Video mode 	Playback, limited recording, limited editing
DVD-R		

Recording speed

You can select a recording speed among 6 options, and the recording time will depend on the recording speed you select as follows.

Disc Size	Recording speed	Recording time *	Video/Sound Quality
8cm Disc	XP	18 min	☆☆☆☆☆☆
	SP	36 min	☆☆☆☆☆
	LP	72 min	☆☆☆☆
	EP	108 min	☆☆☆
	SLP	144 min	☆☆
	SEP	180 min	☆
12 cm Disc	XP	60 min	☆☆☆☆☆☆
	SP	120 min	☆☆☆☆☆
	LP	240 min	☆☆☆☆
	EP	360 min	☆☆☆
	SLP	480 min	☆☆
	SEP	600 min	☆

* The recording time are estimates and actual recording time may differ.

* The audio and video quality is getting poorer as the recording time becomes longer.

* Each time **[REC SPEED]** is press, allowed recording time will be displayed.

Note

- This recorder cannot record on CD-RW or CD-R discs.
- DVD-RW/R and CD-RW/R discs recorded on a personal computer or a DVD or CD recorder may not be played back if the disc is damaged or dirty or if there is dirt or condensation on the player's lens.
- If you record on a disc using a personal computer, there are cases in which it may not be played back because of the settings of the application software used to create the disc, even if it is recorded in a compatible format. (Check with the software publisher for more detailed information.)
- Discs recorded in Video mode on this unit cannot record additionally using other DVD recorders.
- A DVD-RW disc formatted in Video mode with this unit cannot be used on other DVD recorders.
- Since the recording is made by the variable bit rate (VBR) method, the actual remaining time for recording may be a little bit shorter than the remaining time displayed on the OSD, depending on the picture you are recording.

Recording

Information on DVD recording (cont'd)

Restrictions on recording

You cannot record copy-protected discs or tapes using this unit. Copy-protected material includes DVD-Video discs and some satellite broadcasts. If copy-protected material is encountered during a recording, recording will be paused or stop automatically and an error message will be displayed onscreen.

Material that is “copy-once only” can only be recorded using a DVD-RW disc in VR mode with CPRM (see below).



When recording a TV broadcast or through an external input, you can display copy control information on screen.

What is “CPRM”?

This is a format used to record copy-once programs. By recording coded data on the area of DVD discs that ordinary writing software cannot write, it prevents copy-once programs from being recorded repeatedly on different media. This unit is CPRM compatible, which means that you can record copy-once broadcast programs, but then you cannot make a copy of those recordings. CPRM recordings can only be made on DVD-RW discs formatted in VR mode, and CPRM recordings can only be played back on DVD players that are compatible with CPRM.

Information on copy control

Some satellite broadcasts include copy-protected information. For their recording, refer to the following.

Disc type / format	Copy-free	Copy-once	Copy-prohibited
 ver.1.1,1.2 ver.1.1,1.2 CPRM compatible	☆	—	—
	☆	☆	—
 ver.1.1,1.2 ver.1.1,1.2 CPRM compatible	☆	—	—
	☆	—	—
 ver.2.0	☆	—	—

☆ Recordable

— Not Recordable

Making discs playable on other DVD player (Finalize)

After recording, you must finalize the disc in order to play on other units. (Refer to page 40.)

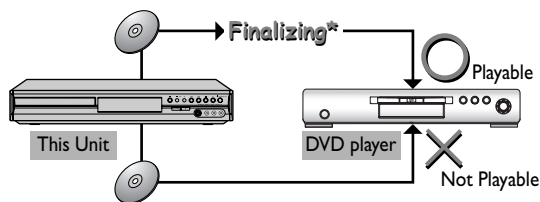

* You cannot finalize discs recorded in other DVD recorders.

After finalizing:

- After DVD-R discs are finalized :
 - A title menu is created automatically.
 - Undo finalizing is not possible.
 - Additional recording or editing is not possible.
- After DVD-RW (Video mode) discs are finalized :
 - A title menu is created automatically.
 - Undo finalizing is possible. (Refer to page 40.)
 - Additional recording or editing is possible if you undo finalize. (Refer to page 40.)
- After DVD-RW (VR mode) is finalized :
 - A title menu is not created.
 - Undo finalizing is possible. (Refer to page 40.)
 - Additional recording or editing is possible even without undo finalizing.

Recording

Formatting a disc

Choosing the recording format of a blank disc



When inserting a blank disc, the unit starts to initialize it automatically. After that, you can record on the disc with a recording format selected in the Setting menu.

1 Press [SET UP].

Easy Setting Menu or Advanced Setting Menu will appear. If Easy Setting Menu is displayed, proceed to step 3.

2 (Advanced Setting Menu only) Using [▲ / ▼], select “Recording”. Press [ENTER]. Recording menu will appear.

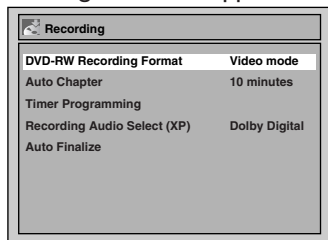

3 Using [▲ / ▼], select “DVD-RW Recording Format”. Press [ENTER].

Option window will appear.

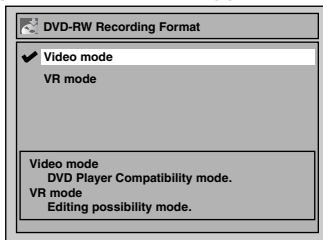

The default is set as “Video mode”.

4 Using [▲ / ▼], select “Video mode” or “VR mode”. Press [ENTER].

The recording format will be set.

5 Press [SET UP] to exit.

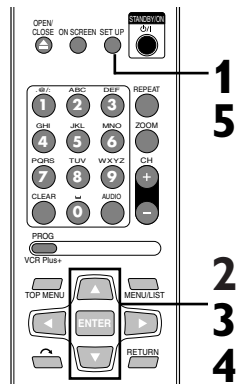

Note

- The recording format setting is effective only for DVD-RW discs. You cannot change the recording format for a DVD-R disc. DVD-R discs will always be in Video mode.
- You cannot mix two formats on one DVD-RW disc. When you load a disc once recorded before, the recording format cannot be changed even if you change it in the Setting menu.
- When inserting a blank DVD+RW or DVD+R disc, the error message (“Disc Error”) will appear. You cannot record on a DVD+RW/R. On this unit, DVD+RW and DVD+R are for playback only.
- PLAYLIST will be created automatically when recording on DVD-RW in VR mode.

Setting Auto Chapter



You can set specific time interval for chapter marks. (Advanced Setting Menu only)

1 Press [SET UP]. Using [▲ / ▼], select “Advanced Setting Menu”. Press [ENTER].

2 Using [▲ / ▼], select “Recording”. Press [ENTER]. Recording menu will appear.

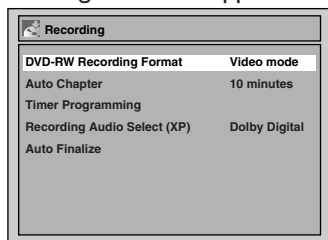

3 Using [▲ / ▼], select “Auto Chapter”. Press [ENTER].

Option window will appear.

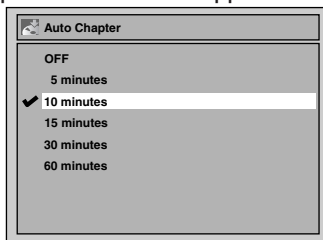

The default is set as “10 minutes”.

4 Using [▲ / ▼], select a desired time option. Press [ENTER]. Chapter marks will be put as you specified.

5 Press [SET UP] to exit.

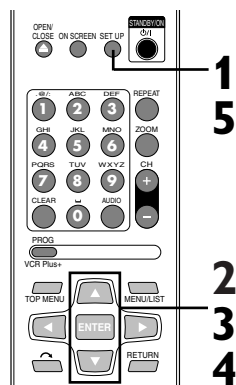

Note

- In Video mode, Auto Chapter may not show up as you specified.
- A blank chapter may be created depending on the remaining time of the disc.

Recording

Formatting a disc (cont'd)

Reformatting a disc



Video mode is the default recording format for DVD-RW. You can change it to VR mode from the Setting Menu.

1
Press [SET UP].

Easy Setting Menu or Advanced Setting Menu will appear.

2
Using [▲ / ▼], select “Disc”.
Press [ENTER].

Disc menu will appear.

3
Using [▲ / ▼], select
“Format”. Press [ENTER].
Confirmation window will appear.

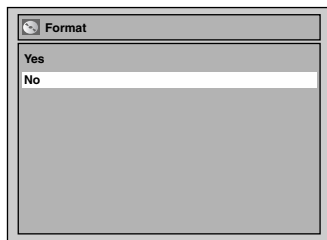

4
Using [▲ / ▼], select “Yes”.
Press [ENTER].

Final confirmation window will appear.

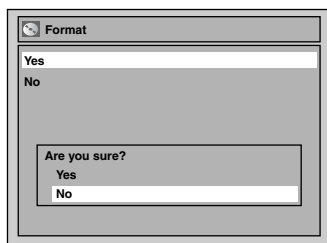

5
Using [▲ / ▼], select “Yes”.
Press [ENTER].

Formatting will start.

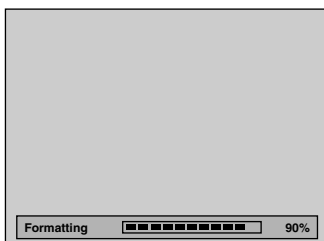

6
Formatting is complete.
100% will be indicated.

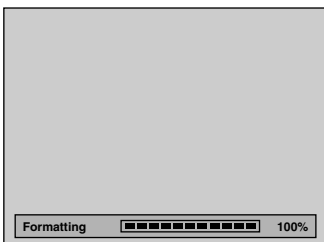

This operation may take a while to be completed.

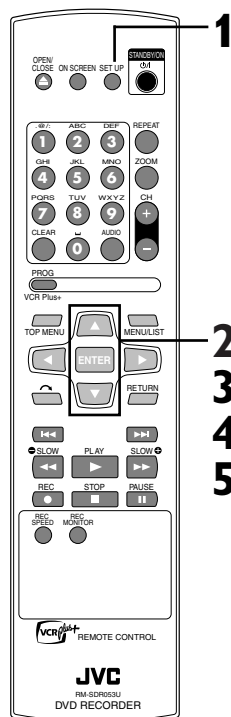

Note

- When you reformat the disc, all contents of the disc will be erased.
- If you want to cancel formatting at step 3 or 4, select “No”.
- A disc once formatted in Video mode with this unit cannot be used on other DVD recorders.

Recording

Recording Audio Select (XP)



You can enjoy high quality sound recording. This function works only when the recording speed is set at XP.

1

Press [SET UP].

Easy Setting Menu or Advanced Setting Menu will appear.

If Advanced Setting Menu is displayed, proceed to STEP 3.

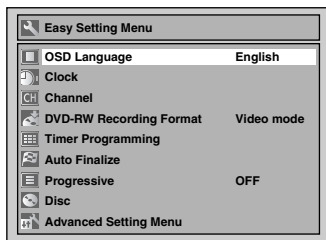

2

Select "Advanced Setting Menu" using [▲ / ▼], then press [ENTER].

Advanced Setting Menu will appear.

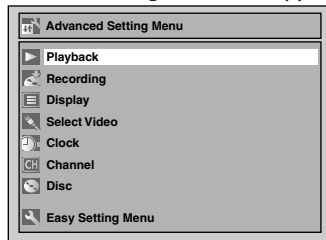

3

Select "Recording" using [▲ / ▼], then press [ENTER].

Recording menu will appear.

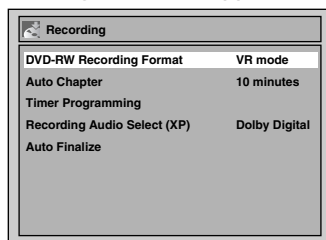

4

Select "Recording Audio Select (XP)" using [▲ / ▼], then press [ENTER].

Option window will appear.

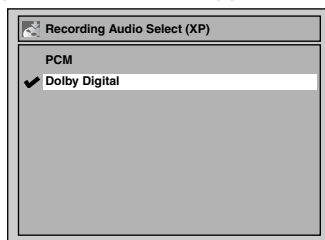

The default is "Dolby Digital".

5

Select "PCM" or "Dolby Digital" using [▲ / ▼], then press [ENTER].

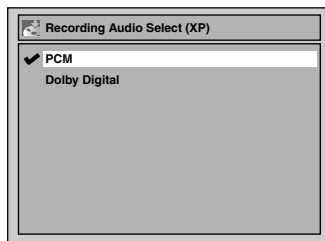

PCM:

Records PCM audio for the best quality sound.

Dolby Digital:

Records Dolby Digital audio for good quality sound.

6

Press [SET UP] to exit.

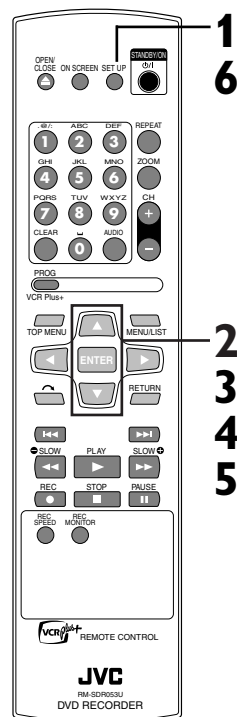

Note

- "PCM" stands for Pulse Code Modulation. It changes analog sound to digital sound without compressing audio data.
- When the recording speed is set at other than XP, the unit records "Dolby Digital" audio automatically even if you selected "PCM".

Recording

Basic recording



Follow steps below to record TV programs.

1

Turn on the unit. Load a recordable disc.

Make sure that the TV input is set on the unit.

This operation may take a while to be recognized.

2

Using [REC SPEED], select a recording speed.



Refer to "Recording speed" on page 26.

3

Make sure that the recording format is set to the desired mode.

Refer to "Formatting a disc" on pages 28-29.

When a DVD-RW disc is loaded:

You can choose Video mode or VR mode from the Setting menu.

"Video mode" has been selected as the default. Refer to "Choosing the recording format of a blank disc" on page 28.

When a DVD-R disc is loaded: DVD-R discs will always be in Video mode.

4

Using [CH + / -] or the Number buttons, select a desired channel to record.



5

Press [REC ●] to start recording.

● mark will be displayed for 5 seconds.



Press [PAUSE II] to pause.

Press [REC ●] to resume.

6

Press [STOP ■] to stop recording.

This operation may take a while to be completed.

Checking the recording picture and sound quality



You can confirm the recording picture and sound quality with the recording speed you have selected before attempting to record to a DVD disc.

1

While in the stop or recording mode, press [REC MONITOR].

The TV program will be on the screen in the recording picture quality and the sound will be output in the recording sound quality with the recording speed you have selected.



Press [REC SPEED] repeatedly to change the recording speed.

The recording speed will be changed as you press the button as shown below. Refer to "Recording speed" on page 26.

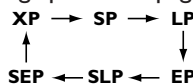

• You cannot change the recording speed during recording.

2

Press [REC MONITOR] again to exit.

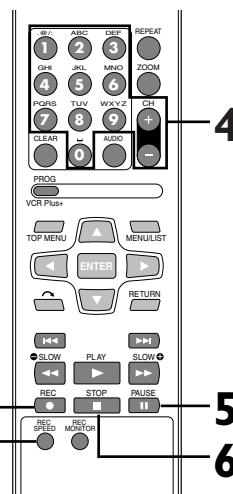

Note

- Recording starts immediately after you press [REC ●] and continues until the disc is full or you stop recording.
- When the clock setting has not been made, the space for a date and time of title names in the Original or Playlist will be blank.
- When you record a TV program broadcasted in both Stereo and SAP-audio on a DVD-RW/R, you have to select the TV channel audio (Stereo or SAP) beforehand. Only the selected channel audio will be recorded. Refer to "Selecting the TV stereo or SAP" on page 22 for more details.
- You cannot change the recording speed during the REC pause mode.
- You can change channels during the REC pause mode.

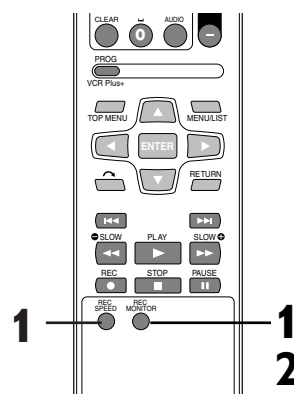

Note

- If you press [REC MONITOR] while receiving the bilingual broadcast, the sound to be recorded is output.

Recording

One-touch Timer Recording



This is a simple way to set the recording time in blocks of 30 minutes. Check that the disc has enough recordable space for the time you set.

After finishing the recording, the recorder automatically goes into standby.

1

Turn on the unit and load a recordable disc.

Make sure that the TV input is set on the unit.

This operation may take a while to be recognized.

2

Using [REC SPEED], select a recording speed.

Refer to "Recording speed" on page 26.

3

Make sure that the recording format is set to the desired mode.

Refer to "Formatting a disc" on pages 28-29.

When a DVD-RW disc is loaded:

You can choose Video mode or VR mode from the Setting menu. "Video mode" has been selected as the default. Refer to page 28 "Choosing the recording format of a blank disc."

When a DVD-R disc is loaded:

DVD-R discs will always be in Video mode.

4

Using [CH + / -] or the Number buttons, select a desired channel to record.

5

Press [REC ●] repeatedly to select a desired recording time.

Recording time appears on the TV screen (30 minutes to 4 hours).

Recording will start.

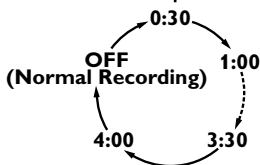
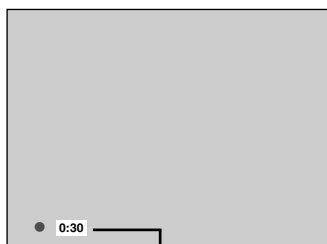

When the unit reaches the specified time, it will turn off automatically.

To change the recording time during the one-touch Timer Recording, press [REC ●] repeatedly until the desired time appears.

To cancel the one-touch Timer Recording within the specified time, press [STOP ■].

This operation may take a while to be completed.

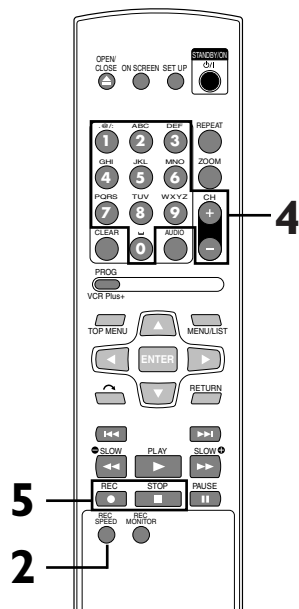

Note

- The remaining recording time will appear on the display panel during an one-touch Timer Recording. Press [ON SCREEN] to see it on the TV screen.
- You cannot pause a one-touch Timer Recording.
- Unlike a Timer Recording, you can perform the following operations during a one-touch Timer Recording.
 - Turning off the power.
 - Using [REC ●] and [STOP ■].
- The unit will be turned off automatically under the following conditions.
 - No space remained on the disc.
 - When a power failure occurs.
- When OTR is finished and the power is turned off, the unit will switch to the standby mode automatically if a Timer Recording has been programmed. Press [STANDBY/ON ○/I] to cancel the standby mode for using the unit continuously.

Recording

Timer Recording



You can program the unit to record up to 8 programs within a month in advance. Daily or weekly program recordings are also available.

- Be sure to set the clock before programming a timer recording.
- Insert a recordable disc.

1

Press **[SET UP]**.

Easy Setting Menu or Advanced Setting Menu will appear. If Easy Setting Menu is displayed, proceed to step 3.

2 (Advanced Setting Menu only)

Using **[▲ / ▼]**, select "Recording". Press **[ENTER]**. Recording menu will appear.

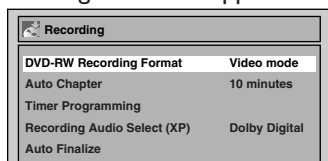

3

Using **[▲ / ▼]**, select "Timer Programming". Press **[ENTER]**.

Timer Programming list will appear.

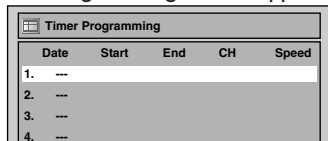

4

Using **[▲ / ▼]**, select a program number. Press **[ENTER]**.

5

Using **[▲ / ▼]**, enter the date. Press **[▶]**.

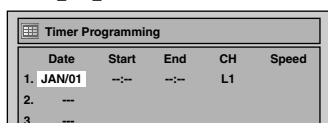

When pressing **[▼]** at the current date, Timer Recording mode will change as follows.

e.g. January 1st

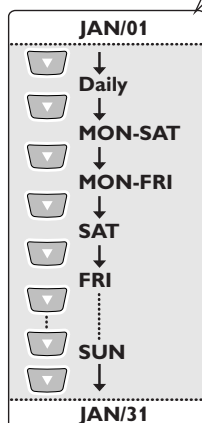

6

Using **[▲ / ▼]**, enter start and end time. Press **[▶]**.

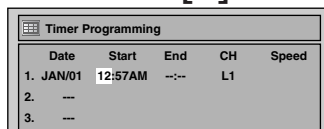

7

Using **[▲ / ▼]**, select the channel number. Press **[▶]**.

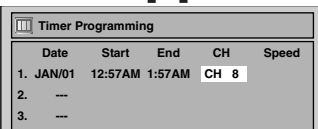

To record from external input, select L1 or L2.

8

Using **[▲ / ▼]**, select a recording speed.

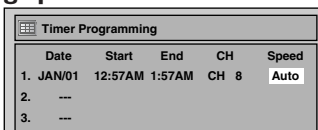

Refer to "Recording speed" on page 26.

If you choose Auto, the unit automatically selects the best recording speed to make the best quality picture according to the remaining disc space.

- This function works only on the Program 1.
- The recording may be cut short, when the available recording space of the disc is too limited.

You can choose the timer programming menu by pressing **[PROG/VCR Plus+]** twice. In this case, continue with step 4.

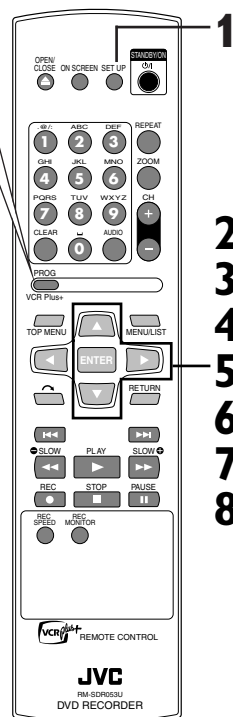

Note

• If you have not set the clock yet:

A clock setting window will appear after step 3. Continue with step 4 in "Auto Clock Setting" on page 23 or "Manual Clock Setting" on page 24 before setting a timer programming.

- Press **[◀ / ▶]** to move the cursor to the left and the right on the timer programming menu.
- After step 10, the recording will start immediately before the recording time you set.

Recording

Timer Recording (cont'd)

- 9**
Press [ENTER] when information is entered.
 Your program setting will be stored.
- To set another program, repeat steps 4 to 9.
 - To exit, press **[SET UP]**.
 - When programs are overlapped, "Overlap" and the overlapped program numbers will appear on the display.

- 10**
Press [STANDBY/ON ϕ /I].
 The unit will be set in the timer standby mode.
 ϕ indicator will appear on the front display.

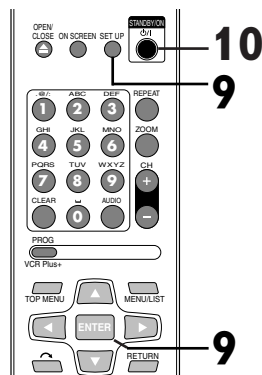
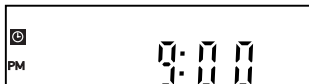

Checking, canceling or correcting the timer programming information

- 1**
Press [STANDBY/ON ϕ /I].
 ϕ indicator disappears from the front display.

- 2**
Press [PROG/VCR Plus+] twice.
 Timer Programming list will appear.

Timer Programming				
Date	Start	End	CH	Speed
1.	---			
2.	---			
3.	---			
4.	---			

- 3**
Check the information on the list you will need.

- 4**
To clear the timer programming:
Using [\blacktriangle / \blacktriangledown], select the program. Press [CLEAR].

- To correct the timer programming:**
Using [\blacktriangle / \blacktriangledown], select the program. Press [ENTER].
 Next, correct the timer programming using [\blacktriangle / \blacktriangledown / \blacktriangleleft / \blacktriangleright].
 Finally, press [ENTER] again.

- 5**
Press [PROG/VCR Plus+] to exit.

- 6**
Press [STANDBY/ON ϕ /I] to return to the timer standby mode.

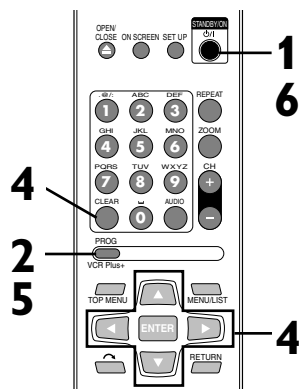

- Note**
- Press **[PROG/VCR Plus+]** twice to confirm the timer programming.
 - When the Timer Recording is in progress, that program will be highlighted in red. In this case, you cannot select any other program for correction or add any new programs.
 - You cannot select any programs for correction or add new programs while the unit is in timer standby mode.
 - The unit will be turned on automatically before the recording time.

To stop the Timer Recording in progress

Press **[STOP ■]** to stop the disc recording on the front panel of the main unit. **[STOP ■]** on the remote control is not effective.

Recording

Timer Recording (cont'd)

If the timer program did not complete correctly, the error number appears on the timer programming list.

Date	Start	End	CH	Speed
* JAN/01	12:57AM	1:57AM	CH8	E22
2.	---			
3.	---			

— Error number will appear

Note

- A program with the error number is highlighted in gray of the asterisked line in the timer programming list.
- Once the timer programming list with error indication is displayed, the program line(s) with error will be cleared only after the programs are canceled and reset to the timer standby mode.
- The current recording program will be highlighted in red.

Each error number means:

E1-22	Recording error other than below	E36	Already finalized Video format disc
E23-24	Unrecordable disc	E40	Some portion has not been recorded because of program overlapping. Recording did not start at the start time.
E25-28	Copy prohibited program		
E29	Disc protected		
E30	Disc full		
E31-32	Already 99 titles recorded	E41	Power failed
E33	Already 999 chapters recorded	E42	No disc when recording
E34	No space for Control information		
E35	PCA full		



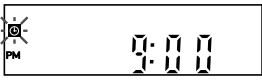





Explanation on the front panel indicator during Timer Recording

	Lights off	Lights on	Flashing
 (CLOCK) mark 	<ul style="list-style-type: none"> - An OTR is completed, and there is no other timer recordings in standby. - The timer standby mode is cancelled by pressing [STANDBY/ON ○/I]. - [STANDBY/ON ○/I] is pressed during timer standby, and the component that is not in timer standby mode is turned on. 	<ul style="list-style-type: none"> - The unit entered into the timer standby mode. - A Timer Recording or an OTR has started. - When this indicator is on, you cannot use [SET UP]. 	<ul style="list-style-type: none"> - All timer recordings are completed. - The DVD entered into the timer standby mode when no disc or an unrecordable disc is in the unit. - The disc runs out of the space during Timer Recording.

Recording

Timer Recording (cont'd)

Hints for Timer Recording

- If there is a power failure or this unit has been unplugged for more than 30 seconds, the clock setting and all timer settings will be lost.
- If a recordable disc is not on the tray, the  indicator flashes and Timer Recording cannot be performed. In some cases, the  indicator appears momentarily around the start point as the unit attempts to record. Please insert a recordable disc.
- When all the Timer Recording is completed, the  indicator flashes. To play or eject the recorded disc, press **[STANDBY/ON /I]** first, and then press **[PLAY▶]** or **[OPEN/CLOSE ▲]**.
- During Timer Recording or timer standby ( indicator is on the front display), any operations on the unit will not be available. To make these operations available, cancel the Timer Recording or timer standby first ( indicator disappears).
- To cancel the timer standby mode, press **[STANDBY/ON /I]**.
- When the Start and the End time are the same, the length of the recording will be set for 24 hours.
- When the disc reaches at the end during the Timer Recording, the unit turns itself off.
- When the programmed Start and End time are earlier than the current time, the setting will not be accepted and be cleared for redoing.
- If the Start time is earlier and the End time is later than the current time, the recording will start right after you press **[STANDBY/ON /I]**.

The priority of overlapped settings

This unit records the programs according to priority if the timer programmings are overlapped. The timer programming set previously has priority.

A Timer Recording of lower priority will be canceled, start from the middle or stop on the way.

Check the overlapped timer programmings and change the priority if necessary.

■ A programming set previously has priority

When the starting time is same:

A program set previously (PROG. 1) has priority.

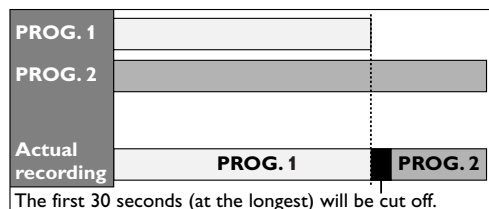

When some programming have been made at the end time of the programming currently being recorded:

A program set previously (PROG. 2) has priority.

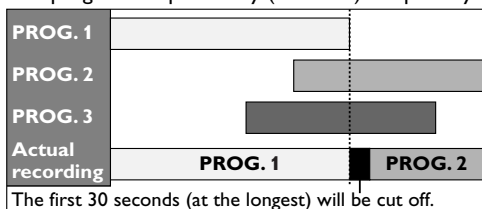

■ When the recording time is partially overlapped: PROG. 1 will start after PROG. 2 is complete to be recorded.

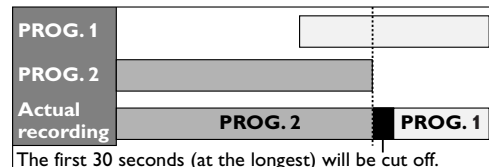

■ When the recording time is entirely overlapped: PROG. 1 will not be recorded.

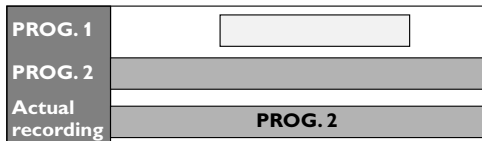

Note for DVD recording

- When the recording time of two programs are overlapped, or the End time of a program and the Start time of another is the same, the first 30 seconds (at the longest) of the subsequent program will be cut off.
- If the cut-off portion comes up to one minute or more, this program will be displayed with error number E40 in the timer programming list.

■ When the End time of the programming currently being recorded and the Start time of the subsequent program are same:

If PROG. 1 is a DVD recording program, the beginning of the PROG. 2 may be cut off.

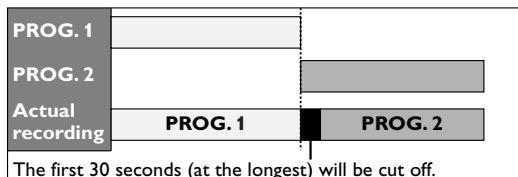

Recording

Timer recording using the VCR Plus+® system



The VCR Plus+ system let you set timer recordings very simply. Just enter the PlusCode number listed in the TV program guide. The date, time and channel for the TV program to record will set automatically.

Before setting timer recording using the VCR Plus+ system, read "Guide channel setting" on pages 20-21.

1
In stop mode, press **[PROG/VCR Plus+]**.

VCR Plus+ setting menu will appear.

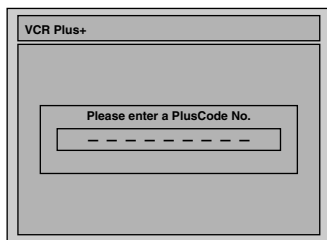

Note:

When eight timer recordings have been scheduled, the Timer Programming list will appear instead.

2
Using the Number buttons, enter the PlusCode number correctly.

Press **[ENTER]**.

The Timer Programming list will appear.

3
Check the highlighted program. You can change the setting by using **[▲ / ▼ / ◀ / ▶]**.

Timer Programming					
	Date	Start	End	CH	Speed
1.	JAN/01	12:57AM	1:57AM	CH 8	XP
2.	---	---	---	---	---
3.	---	---	---	---	---
4.	---	---	---	---	---
5.	---	---	---	---	---
6.	---	---	---	---	---
7.	---	---	---	---	---
8.	---	---	---	---	---

If the Guide channel has not been assigned, the CH column in the highlighted program will be selected. Using **[▲ / ▼]**, enter the channel number to record.

4
Press **[ENTER]** to confirm the Timer Programming. Your VCR Plus+ program setting will be stored.

5
Press **[PROG/VCR Plus+]** to exit.

6
Press **[STANDBY/ON ⏻/⏻]**. The unit will be set in the timer standby mode.

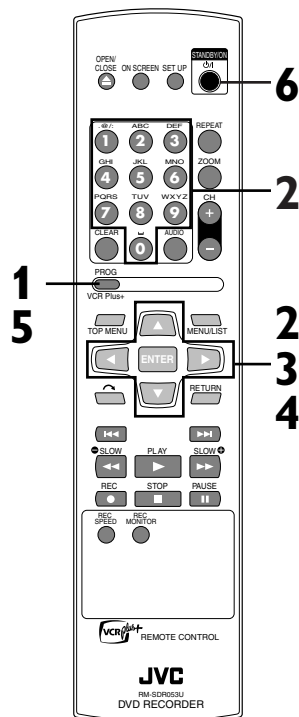

Note

- Press **[◀]** to erase the latest number entered incorrectly at step 2.
- Press **[CLEAR]** to erase all numbers entered incorrectly at step 2.
- If you enter an incorrect PlusCode number at step 2 or the programming is not available, the error message "Code Error!" will appear. Enter the correct PlusCode number.

Remember:

If your cable box or satellite box is connected as in "Connection to a cable box or satellite box" on page 14, TV Channel number must be channel 3 or 4 for every guide channel number. Then set your cable box or satellite box to the channel you want to record; leave your cable box or satellite box on for the timer recording.

Before you start

Connections

Getting started

Recording

Disc Playback

Editing

Changing the Setting menu

Others

Recording

Settings for an external source

Connection to an external source



Connect the external source properly to the unit by using input jacks either LINE2 (Front) or LINE1 (Rear). When connecting an external equipment of monaural output to this unit, use AUDIO L jack of LINE 1 (Rear) or LINE 2 (Front).

Use commercially available S-Video or Video cable and an Audio cable for this type of connection.

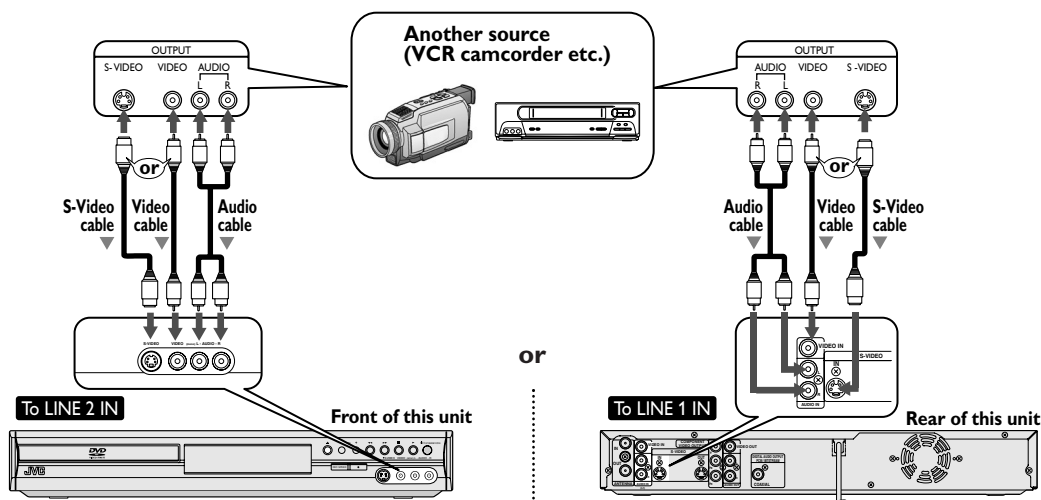

1. Press [SET UP] to display Easy Setting Menu or Advanced Setting Menu.
If Advanced Setting Menu is displayed, proceed to step 3.
2. Using [▲ / ▼], select “Advanced Setting Menu”. Press [ENTER].
3. Using [▲ / ▼], select “Select Video”. Press [ENTER].

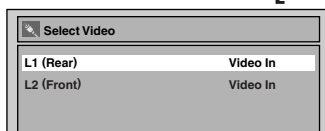

4. Using [▲ / ▼], select “L2 (Front)”. Press [ENTER].

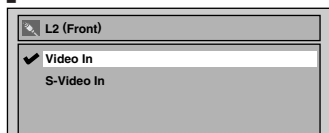

5. Using [▲ / ▼], select the input jack type to connect. Press [ENTER].
If you want to use S-VIDEO input, select “S-Video In”.
If you want to use VIDEO input (Composite), select “Video In”.

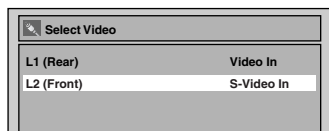

4. Using [▲ / ▼], select “L1 (Rear)”. Press [ENTER].

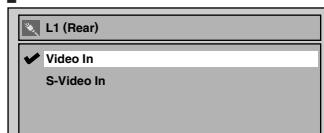

5. Using [▲ / ▼], select the input jack type to connect. Press [ENTER].
If you want to use S-VIDEO IN, select “S-Video In”.
If you want to use VIDEO IN (Composite), select “Video In”.

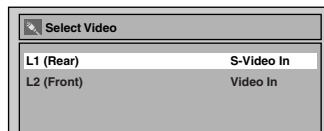

Recording

Settings for an external source (cont'd)

Recording from an external source



Before recording from an external source, see the instructions for the connection on page 38.

1. Turn on the TV and the unit and be sure to select the input of the TV to which the unit is connected.
Refer to the table on page 13.
2. Press [OPEN/CLOSE ▲] to open the disc tray. Place the disc to record properly.
3. Press [OPEN/CLOSE ▲] to close the disc tray.

This operation may take a while to be recognized.

4. Select the input of the unit which the external equipment is connected (L2 or L1).
 - To use the input jacks on the back of this unit, select "L1" position by pressing [0], [0], [1] on the remote control or [CH + / -].
 - To use the input jacks on the front of this unit, select "L2" position by pressing [0], [0], [2] on the remote control or [CH + / -].

5. Select a recording speed by pressing [REC SPEED].

Refer to "Recording speed" on page 26.

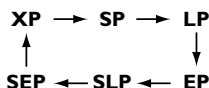

6. Press [REC ●] on the unit to start recording.

7. Press "Play" on the external source to record from.

8. Press [STOP ■] on the unit to stop recording.

This operation may take a while to be completed.

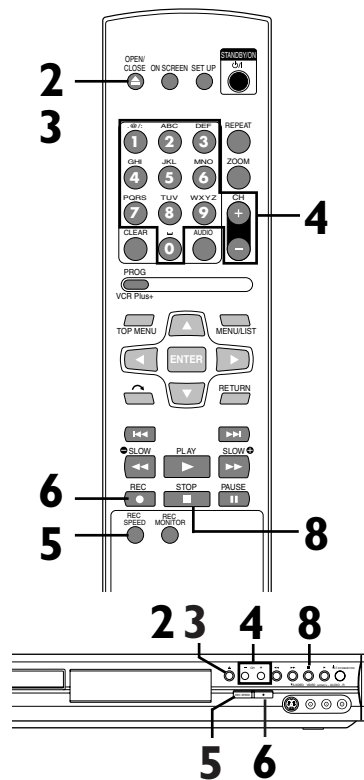

Setting a disc to protect



To prevent accidental recording, editing or erasing of the titles, you can protect them from the Setting menu.

- 1 Press [SET UP].
Easy Setting Menu or Advanced Setting Menu will appear.
- 2 Using [▲ / ▼], select "Disc".
Press [ENTER].
Disc menu will appear.
- 3 Using [▲ / ▼], select "Disc Protect OFF → ON". Press [ENTER].
Confirm window will appear.

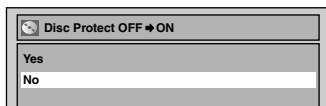

.....
4

Using [▲ / ▼], select "Yes".
Press [ENTER].

A disc will be protected.



This operation may take a while to be completed.

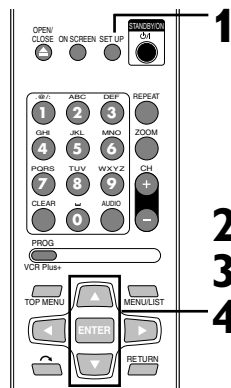

Note

- The Disc Protect setting is available only for a DVD-RW disc recorded in VR mode.
- You can select only Disc Protect off when a protected disc is inserted.

To cancel the disc protect:

- When you insert a disc protected in this unit, "Disc Protect ON → OFF" will appear. To cancel the protection setting for the disc, select "Disc Protect ON → OFF" at step 3, then select "Yes".

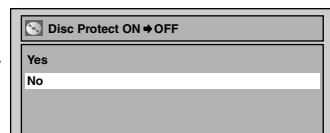

Recording

Finalizing the discs



You will need to finalize discs recorded in Video mode to play them back on other DVD players. Finalizing may take several minutes up to an hour. (It can take up to 15 minutes for a disc recorded in Video mode and 60 minutes for a disc recorded in VR mode.)

A shorter recording period on the disc will require a longer time period for finalization. Do not unplug the power cord during finalization. Details are on pages 26-27.

1

Press **[SET UP]**.

Easy Setting Menu or Advanced Setting Menu will appear.

2

Using **[▲ / ▼]**, select “Disc”. Press **[ENTER]**.

Disc menu will appear.

3

Using **[▲ / ▼]**, select “Finalize”. Press **[ENTER]**.

Confirmation window will appear.

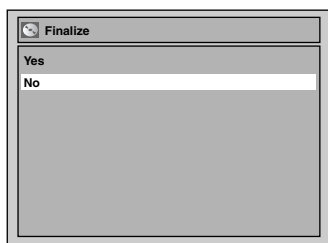

4

Using **[▲ / ▼]**, select “Yes”. Press **[ENTER]**.

Finalizing will start.



To cancel finalizing... (DVD-RW only)

- To cancel finalizing at step 4, press **[STOP ■]**, select “Yes”, then press **[ENTER]**. Finalizing is cancelled and the DVD recorder will be in stop mode.

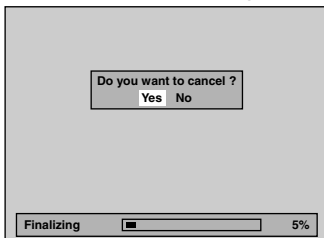

- If **⊙** appear when pressing **[STOP ■]**, you cannot cancel finalizing because the finalizing has progressed a certain point.
- When selecting “No”, press **[ENTER]** or **[RETURN]**, finalizing will be continued.
- You cannot cancel finalizing the DVD-R disc once it has started.

This operation may take a while to be completed.

5

Finalizing is complete.

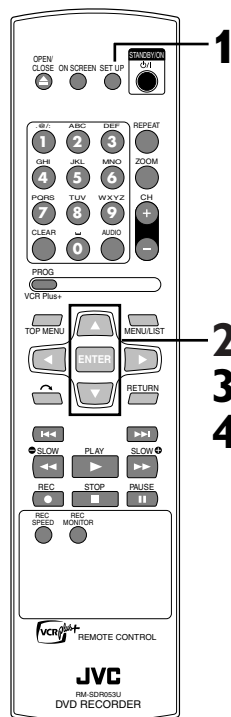

Note

- Finalizing discs in Video mode automatically creates title menus.
- Once you have finalized a disc recorded in Video mode, you cannot edit or record anything else on that disc. Discs recorded in VR mode can still be recorded and edited on this unit even after finalization.
- When you insert a DVD-RW disc finalized with this unit, “Undo Finalize” will appear instead of “Finalize”.

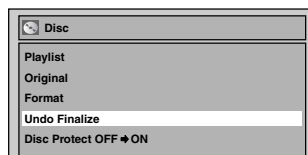

To reverse the finalization of the disc, select “Undo Finalize” at step 3.

*DO NOT power off during finalization. This will result in malfunction.

Recording

Finalizing the discs (cont'd)

Auto finalize



This function automatically finalizes discs after all Timer Recordings are completed and when the disc space runs out.

1

Press [SET UP].

Easy Setting Menu or Advanced Setting Menu will appear. If Easy Setting Menu is displayed, proceed to step 3.

2 (Advanced Setting Menu only)

Using [▲ / ▼], select "Recording". Press [ENTER].

Option window will appear.

3

Using [▲ / ▼], select "Auto Finalize". Press [ENTER].

Option window will appear.

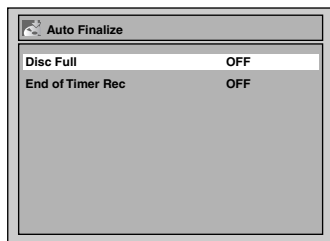

4

Using [▲ / ▼], select "Disc Full" or "End of Timer Rec". Press [ENTER].

Option window will appear.

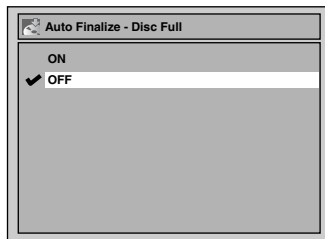

<Example: Disc Full>

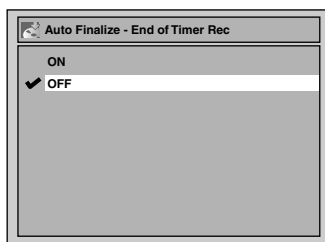

<Example: End of Timer Rec>

5

Using [▲ / ▼], select "ON". Press [ENTER].

Your setting will be activated.

6

Press [SET UP] to exit.

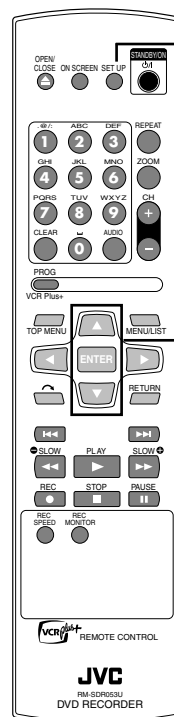

Note

- Auto Finalize is not available for discs recorded in VR mode.









Disc Playback

Information on DVD playback

Before you play back DVD discs, read the following information.

Playable discs

This unit is compatible with the following discs. To play back a DVD, make sure that it meets the requirements for Region Codes and Color Systems as described below. Discs with the following logos can be played back on the unit. Other Disc types are not guaranteed to be played back.

Disc	Logo
DVD-VIDEO	
DVD-RW (VIDEO/VR mode)	
DVD-R (VIDEO mode)	
*DVD+RW	
*DVD+R	
VIDEO CD	
CD-DA (AUDIO CD)	
CD-RW (CD-DA FORMAT, JPEG files)	
CD-R (CD-DA FORMAT, JPEG files)	

DVD is a trademark of DVD Format/Logo Licensing Corporation.

* Some DVD+RW/+R discs may not be operated properly because the unit conforms to the discs recorded in DVD-RW/-R format.

Color systems

DVDs are recorded in different color systems throughout the world. The most common color system is NTSC (which are used primarily in the United States and Canada).

This unit uses NTSC, you must use DVDs recorded in the NTSC system. You cannot play back DVDs recorded in other color systems.

Region codes

This unit has been designed to play back DVD discs with Region One (1). DVDs must be labeled for ALL regions or for Region 1. You cannot play back DVDs labeled for other regions. Look for the symbols below on your DVDs. If these region symbols are not on your DVD, you cannot play back the DVD on this unit.



The number inside the globe refers to region of the world. A DVD labeled for a specific region can only be played back on the unit with the same region code.

Hint for DVD playback

The contents of DVD disc are generally divided into titles. Titles may be further subdivided into chapters.

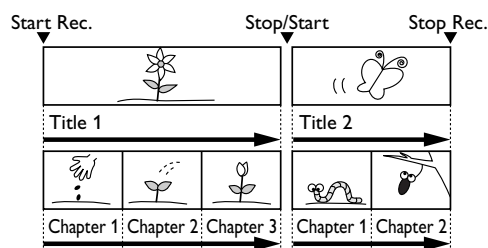

About the PBC function of Video CD

This unit conforms to ver.1.1 and ver.2.0 of Video CD standard, with PBC function.

Ver.1.1 (without PBC function): You can enjoy playback picture as well as music CD.

Ver.2.0 (with PBC function): When using a Video CD with PBC function, "Pbc" appears on the display.

What is PBC? : "PBC" stands for the Play Back Control. You can play interactive software using a menu screens. Refer to instructions of Video CD.

Disc Playback

Basic playback

Playback



1

Press **[STANDBY/ON \odot /I]**.
When you are playing back a DVD,
turn on the TV and be sure to select
the input to which the unit is con-
nected.

2

Press **[OPEN/CLOSE \blacktriangle]**.
The disc tray will open.

3

Insert your disc with its label
facing up. Align the disc to
the disc tray guide.

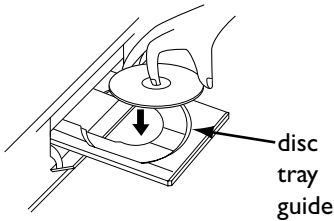

4

Press **[OPEN/CLOSE \blacktriangle]** to
close the disc tray.

This operation may take a
while to be recognized.

5

Press **[TOP MENU]** to dis-
play the title menu.
You can change "Original" or
"Playlist" of VR mode using
[MENU/LIST].

Video mode:

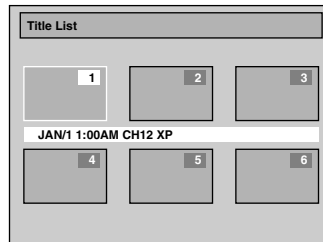

VR mode:

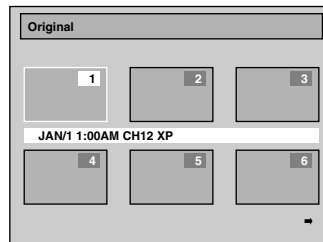

[MENU/LIST]

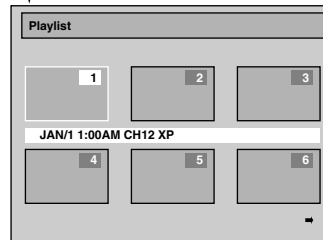

• To exit the title menu, press
[TOP MENU] again.

6

Using **[\blacktriangle / \blacktriangledown / \blacktriangleleft / \blacktriangleright]**, select a
desired title. Press **[ENTER]**.
Playback will start.

7

Press **[STOP \blacksquare]** to stop play-
back.

To eject the disc, press
[OPEN/CLOSE \blacktriangle] to open the
disc tray, then remove the disc
before turning off the unit.

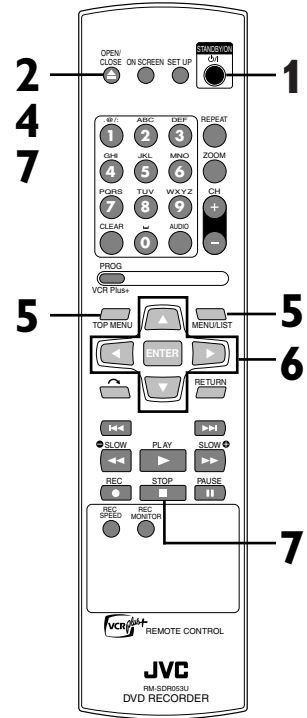

Note

- For DVD-R (Video mode), DVD-RW (Video mode) and DVD+R discs which are already finalized and DVD+RW discs, the Title Menu will be displayed instead of the thumbnails.

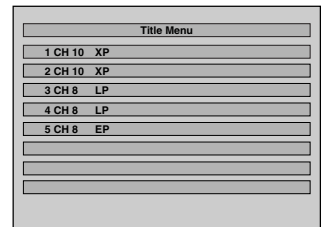

- You can resume playback from the point you stopped playback. (Resume playback) Refer to page 46 for details about resume playback.
- Some discs may start playback automatically.

Disc Playback

Basic playback (cont'd)



1 Press **[STANDBY/ON ⏻/⏻]**.
When you are playing back a DVD or an audio CD, turn on the TV and be sure to select the input to which the unit is connected.

2 Press **[OPEN/CLOSE ▲]** to open the disc tray.
The disc tray will open.

3 Insert your disc with its label facing up. Align the disc to the disc tray guide.

4 Press **[PLAY ▶]** to start playback.
Playback will start.

If you are playing back a DVD-Video or Video CD disc, a menu may appear.
Refer to page 45 for details about a disc menu.

5 Press **[STOP ■]** to stop playback.

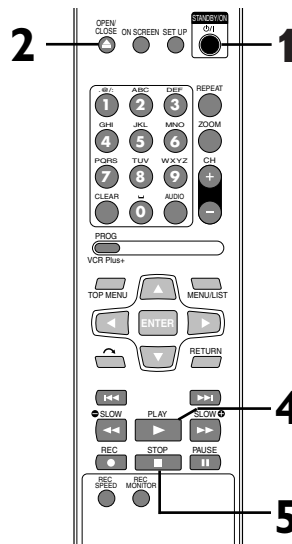

Note

- Some discs may start playback automatically.

Playing back JPEG disc



1 Follow steps 1 to 4 on page 43 to display the title list.
If the disc is in the unit, press **[TOP MENU]** to call up the JPEG menu.

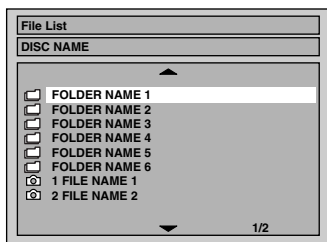

• To exit the menu, press **[TOP MENU]** again.

2 Press **[▲ / ▼]** to select a desired folder (group) or track.
Press **[ENTER]**.

When selecting track:
Playback will start.

When selecting the folder:
The files in the folder will appear.
Press **[▲ / ▼]** to select the track or folder you want, then press **[ENTER]**.

- Press **[PLAY ▶]**, **[ENTER]** or **[▶]** to move to the lower hierarchies.
- Press **[◀]** or **[RETURN]** to go to the previous hierarchy.
- Press **[STOP ■]** to return to the first item.

Hints for JPEG files:

- Folders are known as Groups, files are known as Tracks.
- Folders are accompanied by icon.
- JPEG files are accompanied by icon.
- The system can recognize up to 255 groups (or folders) and up to 255 tracks.
- The name of the group and track can be displayed in up to 29 characters. Unrecognizable characters will be replaced with asterisks.
- If there are no files in the folder, "No Files" will be displayed.

This unit recommends the files recorded under the following circumstances:

<Applicable JPEG files>

- Upper limit: 6,300 x 5,100 dots.
- Lower limit: 32 x 32 dots.
- File size of image maximum: 2.2MB.

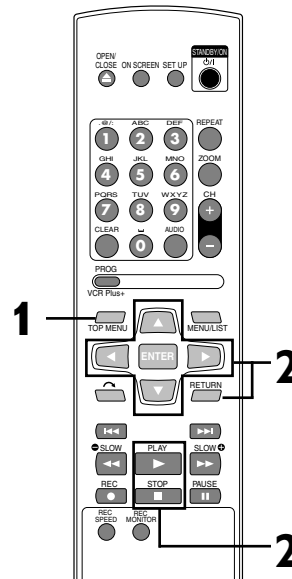

Note

- Files whose extension other than ".jpg / .jpeg (JPEG)" will not appear in the file list.
- High-resolution JPEG files take longer to be displayed.
- During JPEG playback, press **[◀ / ▶]** to rotate a picture 90 degrees clockwise or counterclockwise respectively. (Not available when the display menu appears.)

Disc Playback

Basic playback (cont'd)

Playing back discs using the disc menu



A DVD disc contains a disc menu that describes the contents or allows you to customize the playback. For example, the menu may offer choices for subtitle languages, special features, or chapter selection.

Some discs display them automatically when you start playback. For others, they only appear when you press **[MENU / LIST]**.

1
Press **[MENU/LIST]**.

The disc menu will appear.

If the feature is not available,  may appear on the TV screen.

2
Using **[▲ / ▼ / ◀ / ▶]**, select an item. Press **[ENTER]** to confirm. Continue this step to set up all the features you want or to start playing back the disc from the menu.

MENU/LIST button:

Displays a DVD disc menu. It may be the same with the 'Title menu.'

Cursor ▲ / ▼ / ◀ / ▶ buttons:

Moves the cursor on the screen.

ENTER button:

Selects the currently highlighted menu option.

Number buttons:

Selects a numbered menu option (some discs only). Press **[ENTER]** after.

3
Press **[MENU/LIST]** to exit the disc menu.



1
When "PBC (Video CD only)" in the Disc menu is ON and the display menu is not displayed, the Video CD main menu will appear when inserting a disc or press **[RETURN]** during playback.

If the feature is not available,  may appear on the TV screen.



2
Select an item using the Number buttons to play back.

3
Press **[STOP ■]** to stop playing.

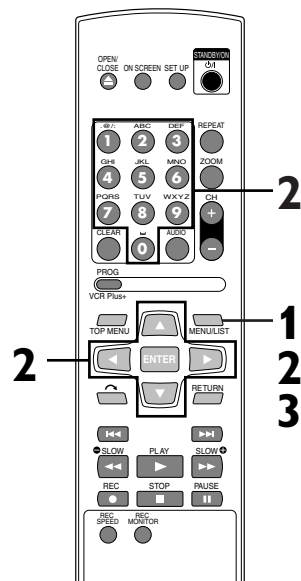

Note

- Menus vary among discs. Refer to the information accompanying the disc for details.

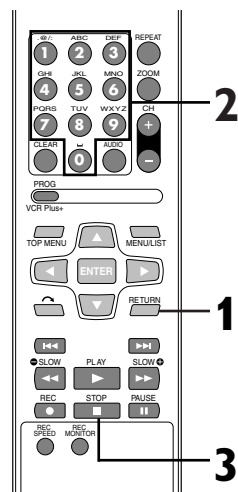

Note

- Menus vary among discs. Refer to the information accompanying the disc for details.

Disc Playback

Basic playback (cont'd)

Playing back discs using the title menu



Some DVDs have a title menu, which lists the titles available on them. It helps you to start playback at a specific title.

- 1 Press **[TOP MENU]**.
The title menu will appear. If the feature is not available, may appear on the TV screen.
- 2 Using the **[▲ / ▼ / ◀ / ▶]**, select a title to play. Press **[ENTER]**.
Playback will begin at the title you selected.

TOP MENU button:
Displays the 'Title menu' of a DVD disc.

Cursor ▲ / ▼ / ◀ / ▶ buttons:
Moves the cursor on the screen.

ENTER button:
Selects the current highlighted menu option.

Number buttons:
Selects a numbered menu option (some discs only). Press **[ENTER]** after.

3 Press **[TOP MENU]** to exit the title menu.

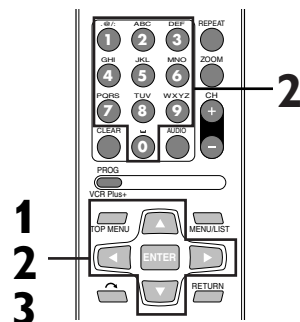

Note

- **[TOP MENU]** will not always be active with all DVDs.
- Menus vary among discs. Refer to the information accompanying the disc for details.

Cancelling and Recalling the PBC function



- 1 In stop mode, press **[SET UP]**.
"Easy Setting Menu" or "Advanced Setting Menu" will appear.
- 2 Select "CD Playback Mode" using **[▲ / ▼]**, then press **[ENTER]**.
- 3 Select "PBC (Video CD only)" using **[▲ / ▼]**, then press **[ENTER]**.

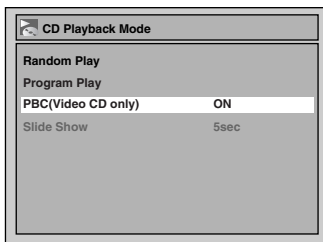

4 Select "OFF" using **[▲ / ▼]**, then press **[ENTER]**.

5 Press **[SET UP]** to exit.
To recall the PBC function, select "ON" in step 4 above.

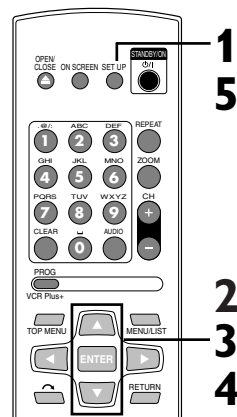

Note

- The default setting of "PBC (Video CD only)" is "ON".

Special playback

Resume playback



You can resume playback from where you stopped it last time.

- 1 During playback, press **[STOP ■]**.
The resume message will appear.

Resume ON

2 Press **[PLAY ▶]**.
Within a few seconds, playback will resume from the point at which it stopped last. You can resume playback at the same point even if you turn off the unit.

To cancel resuming and start disc playback from the beginning, press **[STOP ■]** again while the play is stopped.

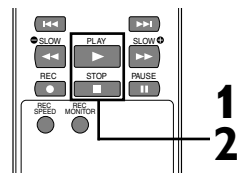

Note

- For JPEG files, playback will resume from the beginning of the track which you stopped playing back.

Disc Playback

Special playback (cont'd)

Fast forward / Fast reverse



1

During playback, press [FWD ►►] or [REW ◄◄].

Every time you press [FWD ►►] or [REW ◄◄], approximate speed will be changed as follows. For DVD discs, sound will be output during x1.5 fast forward only if you set "Fast Forward with Audio" to "ON" at the "Playback" setting in the Setting menu.

Fast forward or fast reverse playback across titles (for DVD discs) or tracks is not possible.



For Video CDs, approximate speed is fixed at x1.5, x8, x16 in fast forward and x2, x8, x16 in fast reverse playback.

For Audio CDs, approximate speed is fixed at x8 with sound.

To return to the normal playback, press [PLAY ►].

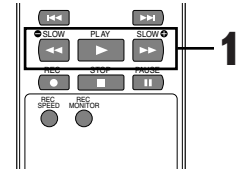

Note

- Forward/reverse speed will be indicated with icons as follows.
- Forward (Approx. Speed)
- x1.5: ►►
 - x20: ►►►
 - x40: ►►►►
- Reverse (Approx. Speed)
- x5: ◄◄
 - x20: ◄◄◄
 - x40: ◄◄◄◄

Skipping TV commercials during playback



You can skip TV commercials by pressing [⏮], in order to enjoy the recorded programs without interruption.

1

During playback, press [⏮].

Normal playback will start at 30-seconds advanced from where you press [⏮].

Every time you press [⏮], the playback starting point will be extended by 30 seconds ahead. You can press up to 6 times (180 seconds).

e.g. Press [⏮] once.

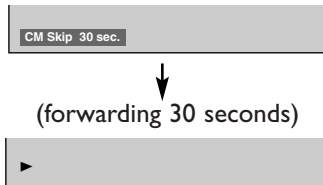

Playback will restart automatically.



Pause



1

During playback, press

[PAUSE II].

Playback will pause and sound will be muted.



2

Press [PLAY ►] to resume play.

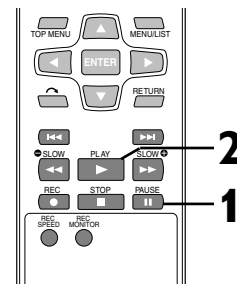

Note

- For JPEG files, playback will resume from the beginning of the track at which playback was stopped.

Disc Playback

Special playback (cont'd)

Step by step playback



1 During playback, press [PAUSE II]. Playback will be paused and sound will be muted.



2 Press [▶▶] repeatedly. The playback will advance one frame (or step) at a time when you press [▶▶]. The sound will be muted.

To playback step by step backward:
Press [◀◀] repeatedly. Every time you press the button, the playback will go backward by one frame at a time.
• Press and hold [◀◀ / ▶▶] to advance/ reverse continuously.

3 Press [PLAY ▶] to resume play.

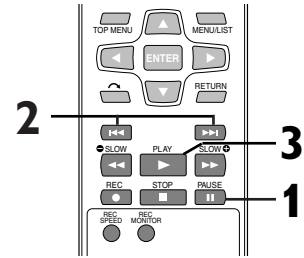

Note
• Reverse step by step playback is not available on Video CDs.

Slow forward / Slow reverse playback



1 During playback, press [PAUSE II]. Press [SLOW ⊕] or [SLOW ⊖]. Every time you press [SLOW ⊕] or [SLOW ⊖], approximate speed will change as follows. (The sound will remain muted.)

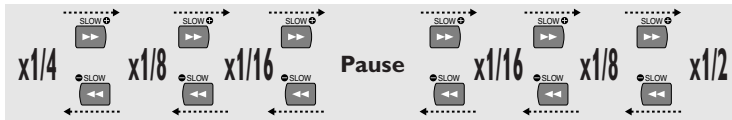

To return to the normal playback, press [PLAY ▶].

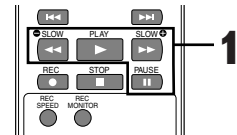

Note
• Forward/reverse speed will be indicated with icons as follows.
Forward (Approx. Speed)
x1/16: ▶▶▶▶
x1/8: ▶▶▶
x1/2: ▶▶▶
Reverse (Approx. Speed)
x1/16: ◀◀◀◀
x1/8: ◀◀◀
x1/4: ◀◀◀
Slow reverse playback is not available on Video CDs.

Zoom



1 During playback, press [ZOOM]. Zoom menu will appear.



There are four options (x1.0, x1.2, x1.5 and x2.0), which will be displayed excluding the current zoom rate.

2 Using [▲ / ▼], select a desired zoom factor to zoom. Press [ENTER]. The zoom area will be displayed.

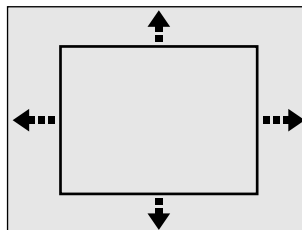

3 Using [▲ / ▼ / ◀ / ▶], select a desired zoom position. Press [ENTER]. The zoom play will start.

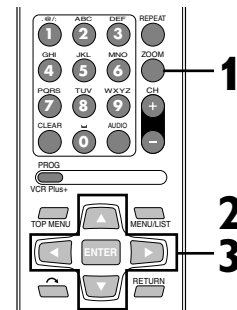

Note
• When selecting a smaller factor than the current one, the zoom area will not be displayed.
• To remove the zoom menu, press [ZOOM] again at step 1.
• To cancel the zoom, select x1.0 using [▲ / ▼], then press [ENTER].

Disc Playback

Special playback (cont'd)

Marker Setup



This function allows you to assign a specific point on a disc to be called back later.

1 During playback, press **[ON SCREEN]**. The display menu will appear.

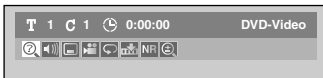

2 Using **[◀ / ▶]**, select **TM** icon. Press **[ENTER]**. Marker setting menu will appear. Screen for DVD:

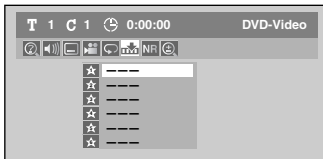

Screen for CD:

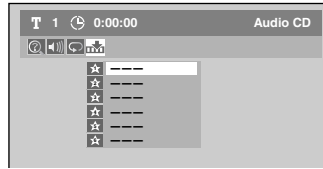

3 Using **[▲ / ▼]**, select a desired marker number. When it reaches the desired point, press **[ENTER]**. The title (track) number and the time will be displayed.

4 To return to the marker later: Using **[▲ / ▼]**, select the desired marker number. Press **[ENTER]**.

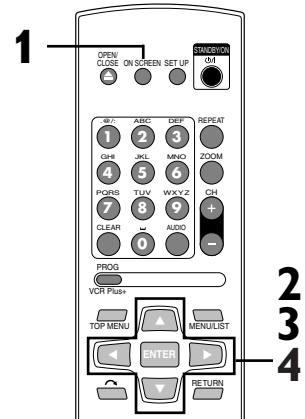

Note

- To clear a marker, select the marker number to be cleared, then press **[CLEAR]**.
- All markers will be erased when you operate these operations listed below.
 - Opening the disc tray.
 - Turning off the power.
 - Recording to a recordable disc.
 - Changing the mode between Original and Playlist.(VR mode)
- You can mark up to 6 points.

Follow Playback during Recording



You can play back the already recorded part of the currently recording program without waiting for the recording to end. This function works from 1 minute after the start of the recording.

1 During recording, press **[PLAY ▶]**.

Playback will start from the beginning of the program that you are currently recording.

Screen for the current playback:



If you play the fast forward playback and the playback reaches the scene recorded 1 minute ago, the forwarding playback will automatically return to the normal playback.

2 Press **[STOP ■]** once to stop playback. The resume message will appear.

Screen for the current recording:

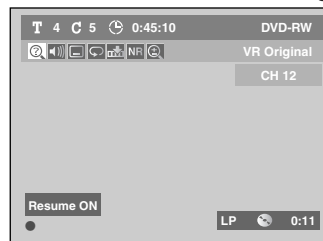

To cancel the resume, press **[STOP ■]** once. To stop recording, press **[STOP ■]** again.

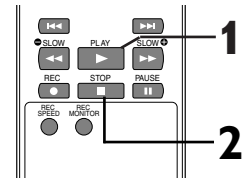

Note

- Playback image may freeze momentarily during the Follow Playback. However this does not affect the recording.
- The x1.5 fast forward is not available.
- You cannot change the recording time length during the Follow Playback.
- “Wait for a moment.” will be displayed on the screen if you press **[PLAY ▶]** within 1 minute of the start of the recording.
- This function is available only when you are recording with DVD-RW in VR mode and the recording speed of LP, EP, SLP, or SEP.

Disc Playback

Special playback (cont'd)

Simultaneous Playback and Recording



You can also play back a recorded title during current recording or the Timer Recording on the same disc.

1

During recording, press **[ON SCREEN]**.

The display menu will appear.

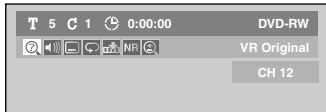

2

Select **[?]** icon using **[◀ / ▶]**, then press **[ENTER]**.

The title number next to **T** will be highlighted.

Title:

Enter a desired title number to search using **[▲ / ▼]** or the **Number** buttons, then press **[ENTER]**.

Selected title will start playback.

Chapter:

To move to **C** for chapter, press **[▶]**.

Enter a desired chapter number to search using **[▲ / ▼]** or the **Number** buttons, then press **[ENTER]**.

Selected chapter will start playback.

3

Press **[STOP ■]** once to stop playback.

The resume message will appear.

Screen for the current recording:



To cancel the resume, press

[STOP ■] once.

To stop recording, press

[STOP ■] again.

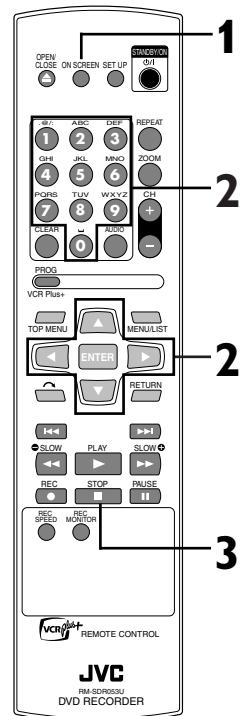

Note

- Only titles (chapters) in the “Original” can be selected. You cannot select titles from the Titles List.
- When you stop the playback after the Timer Recording is completed, the unit will be switched to the timer standby mode if another program has been set (refer to “Hints for Timer Recording” on page 36).
- This function is available only when you are recording with DVD-RW in VR mode and the recording speed of LP, EP, SLP, or SEP.

Disc Playback

Search

Title/Chapter search



Using [◀◀ / ▶▶]

1

During playback, press [▶▶] to skip the current title or chapter and move to the next.

To go back to the beginning of the current title or chapter, press [◀◀]. Press it repeatedly to go to the previous titles or chapters.

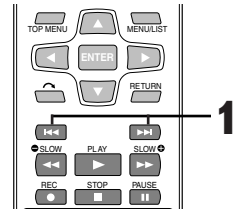

Using [ON SCREEN]

1

During playback, press [ON SCREEN].

The display menu will appear.

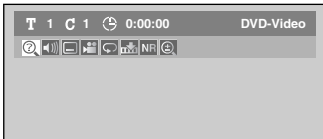

2

Using [◀ / ▶], select icon. Press [ENTER].

The title number next to **T** will be highlighted.

Title:

Using [▲ / ▼] or the Number buttons, enter a desired title number to search. Press [ENTER].

Title search will start.

Chapter:

To move to **C** for chapter, press [▶].

Using [▲ / ▼] or the Number buttons, enter a desired chapter number to search. Press [ENTER].

Chapter search will start.

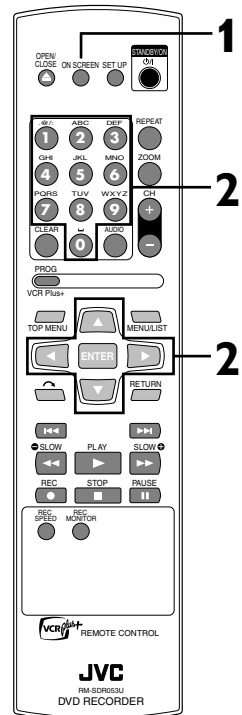

Note

- In search mode display, total numbers of each search contents (title/chapter/time) are shown as a denominator.

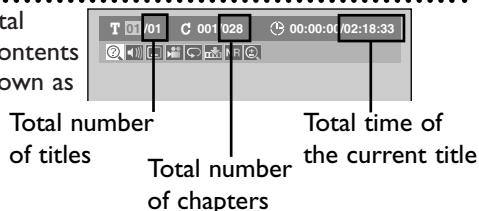

Disc Playback

Search (cont'd)

Track search



Using [◀◀ / ▶▶]

1

During playback, press [▶▶] to skip the current track and move to the next.

To go back to the beginning of the current track, press [◀◀]. Press it repeatedly to go to the previous tracks.

Using [ON SCREEN]

1

During playback, press [ON SCREEN].

The display menu will appear.

Screen for CD:

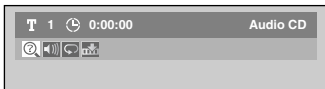

Screen for Video CD:

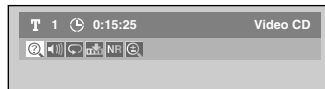

Screen for JPEG:



2

Using [◀ / ▶], select icon. Press [ENTER].

The track number next to **T** will be highlighted.

3

Using [▲ / ▼] or the Number buttons, enter a desired track number to search. Press [ENTER].

Track search will start.

Time search



1

During playback, press [ON SCREEN].

The display menu will appear.

Screen for DVD:

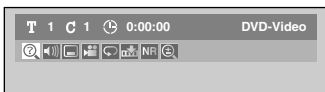

Screen for CD:

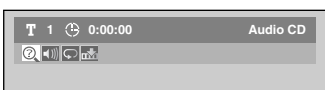

2

Using [◀ / ▶], select icon. Press [ENTER].

The number next to **T** will be highlighted.

To move to the clock icon , press [▶].

When time search is not available, "--:--:--/--:--:--" ("0:00:00/0:00:00" for Video CD and Audio CD) is displayed instead of time count.

3

Using [▲ / ▼] or the Number buttons, enter a desired time to search. Press [ENTER].

Time search will start.

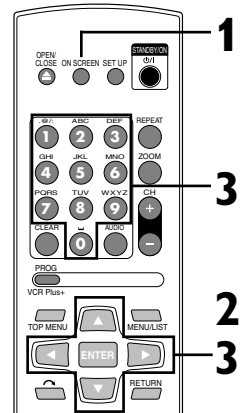
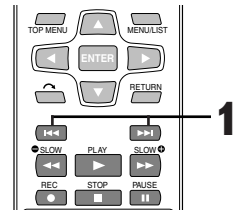

Note

- During CD playback you can enter a track number directly using the **Number buttons** for track search without displaying the menu (except during random and program playback).
- For Video CDs, Audio CDs and JPEG, Track search is not available for programmed or random playback.

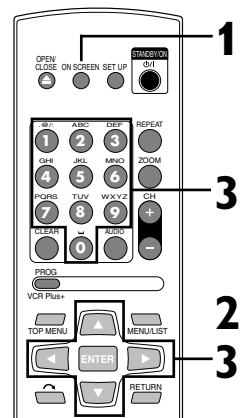

Note

- Time search is available only within the same track or title.

Disc Playback

Repeat/Random/Program playback

Repeat playback



1 During playback, press **[ON SCREEN]**. The display menu will appear.

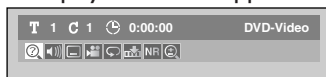

2 Using **[◀ / ▶]**, select  icon. Press **[ENTER]**. Repeat menu will appear.

Screen for DVD:

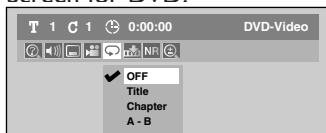

Screen for Audio CD:

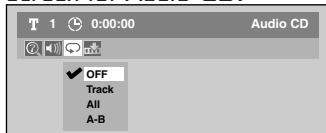

Screen for Video CD:

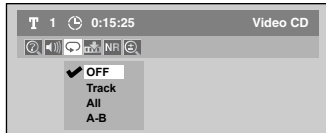

Screen for IPEG:

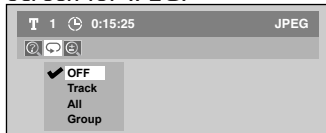

3 Using **[▲ / ▼]**, select a desired option for repeat playback. Press **[ENTER]**.

The selected repeat playback will start.

Title:

The current title will be played back repeatedly. (DVD only)

Chapter:

The current chapter will be played back repeatedly. (DVD only)

All:

The current disc will be played back repeatedly (DVD-RW (VR mode), Audio CD, Video CD and JPEG only).

A-B:

The A-B point will be played back repeatedly.

When pressing **[ENTER]** while A-B is highlighted, the unit becomes ready for the input. Press **[ENTER]** again to decide the starting point (A).

Press **[ENTER]** after setting point A to select the ending point (B) (DVD, Audio CD and Video CD only).

Track:

The current track will be played back repeatedly. (Audio CD, Video CD and JPEG only)

Group:

The current group will be played back repeatedly. (JPEG only)

You can choose the repeat menu by pressing **[REPEAT]**. In this case, continue with step 3.

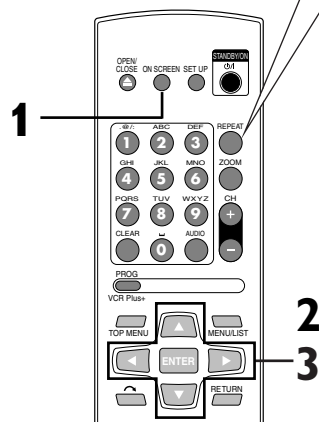

Note

- The A-B Repeat playback can only be set within the current title (for DVDs), or current track (for Video CDs and Audio CDs).
- To cancel the repeat playback, select "OFF" at step 2. The repeat setting will be also cleared when you stop playback.
- You cannot select "Group" for repeat playback during the random playback of JPEG files.
- Repeat playback does not work when playing back Video CD with PBC function.

Random playback



You can play back a disc randomly instead of playing back in the original order.

1 Press **[SET UP]**. Easy Setting Menu or Advanced Setting Menu will appear.

2 Using **[▲ / ▼]**, select "CD Playback Mode". Press **[ENTER]**.

CD Playback Mode menu will appear.

3 Using **[▲ / ▼]**, select "Random Play". Press **[ENTER]**.

Random playback will start.

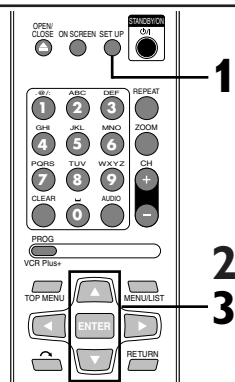

Note

- To cancel random playback, press **[STOP ■]** twice during random playback. "Playmode OFF" appears on the screen.
- Random playback turns off "PBC" automatically when you play back Video CDs with PBC function.

Disc Playback

Repeat/Random/Program playback (cont'd)

Program playback

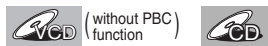

You can program a playback sequence in your desired order.

1 Press **[SET UP]**.

Easy Setting Menu or Advanced Setting Menu will appear.

2 Using **[▲ / ▼]**, select **“CD Playback Mode”**. Press **[ENTER]**.

CD Playback Mode menu will appear.

3 Using **[▲ / ▼]**, select **“Program Play”**. Press **[ENTER]**.

Program play list will appear.

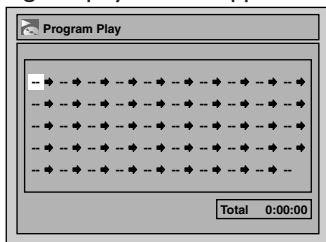

4 Using **[▲ / ▼]** or the **Number buttons**, select a desired track. Press **[ENTER]** or **[▶]**. A cursor will move to the next.

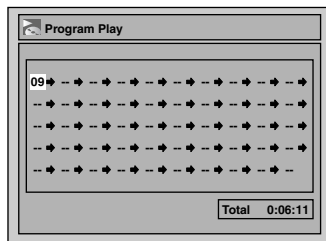

5 Press **[PLAY ▶]** to start program playback. Program playback will start.

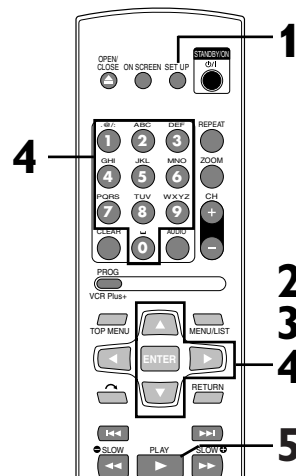

Note

- To erase tracks you selected, press **[CLEAR]**.
- You can make program settings up to 50.
- To cancel program playback, press **[STOP ■]** twice during program playback.
- “Playmode OFF” appears on the screen.
- You may also select a desired track using the **Number buttons** at step 4.
- For Video CDs, the PBC setting will switch to off automatically during program playback.

Slide Show



You can select the display time between 5 seconds and 10 seconds.

1 Press **[SET UP]**. Easy Setting Menu or Advanced Setting Menu will appear.

2 Using **[▲ / ▼]**, select **“CD Playback Mode”**. Press **[ENTER]**. CD Playback Mode menu will appear.

3 Using **[▲ / ▼]**, select **“Slide Show”**. Press **[ENTER]**.

4 Using **[▲ / ▼]**, select a desired time. Press **[ENTER]**.



Note

- Large-size JPEG files take a few moments to be displayed.

Disc Playback

Selecting a format of audio and video

You can select a desired audio and video format. Selections depend on the contents of the disc you are playing back.

Switching subtitles



Many DVD-Video discs have subtitles in one or more languages – they usually tell you which subtitle languages are available. You can switch subtitle languages anytime during playback.

1

During playback, press **[ON SCREEN]**.

Display menu will appear.

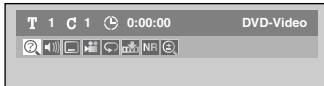

2 Using **[◀ / ▶]**, select  icon. Press **[ENTER]**.
Subtitle menu will appear.

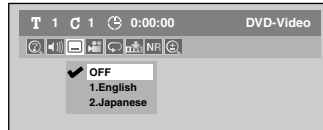

3 Using **[▲ / ▼]**, select a desired subtitle language. Press **[ENTER]**.

Subtitles will be displayed in the selected language. When selecting “OFF,” subtitles will disappear.

Switching audio soundtrack



When playing back a DVD-Video disc recorded with two or more soundtracks (these are often in different languages), you can switch among them during playback.

When playing back DVD-RW discs recorded in VR mode, you can switch to main audio (L), sub audio (R) or a combination of both (L/R). When playing back Audio CDs, you can switch among stereo, the left channel only and the right channel only.

1

During playback, press **[ON SCREEN]**. (or press **[AUDIO]** and follow from step 3.)

2

Using **[◀ / ▶]**, select  icon. Press **[ENTER]**.

Audio menu will appear.

<DVD-Video>

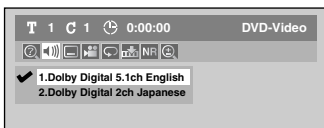

<DVD-RW VR mode>

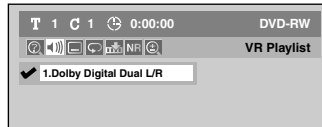

<Audio CD>

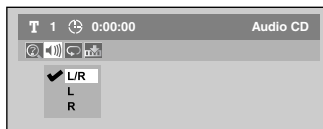

3 Using **[▲ / ▼]**, select a desired audio soundtrack or audio channel. Press **[ENTER]**.

<DVD-Video>

Audio soundtrack will switch.

<DVD-RW VR mode>

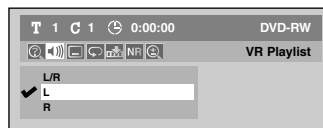

Audio channel menu will appear. Follow step 3.

<Audio CD>

Audio channel will switch.

4 Using **[▲ / ▼]**, select a desired audio channel. Press **[ENTER]**.

Audio channel will switch.

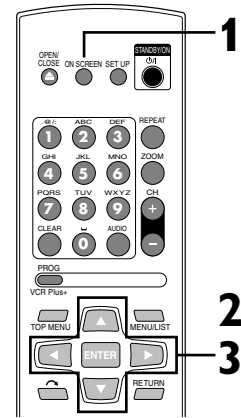

Note

- Some discs will only allow you to change subtitles from the disc's menu. Press **[TOP MENU]** or **[MENU/LIST]** to display the disc menu.
- If a 4-digit language code appears in the subtitle menu at step 2, refer to the Language code on page 84.

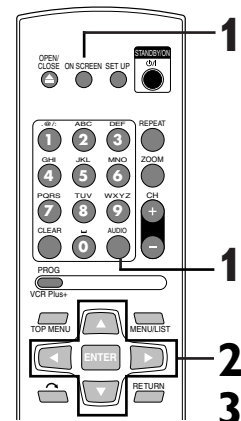

Note

- Some discs will only allow you to change the soundtrack from the disc menu. Press **[TOP MENU]** or **[MENU/LIST]** to display the disc menu.
- On DVD-RW discs recorded in VR mode with both main and sub audio, you can switch to main (L), sub audio (R) or a mix of both (L/R).
- This unit CANNOT record in both stereo and SAP (Secondary Audio Program) at the same time.

Disc Playback

Selecting a format of audio and video (cont'd)

Switching camera angles



Some DVD-Video discs feature scenes shot from two or more angles. The disc package should be marked with an angle icon if it contains multi-angle scenes.

1

During playback, press [ON SCREEN].

Display menu will appear.

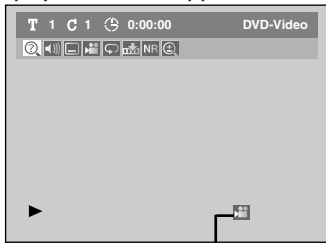

Angle icon appears when different camera angles are available.

2

Using [◀ / ▶], select  icon. Press [ENTER].

Angle will change each time you press [ENTER].

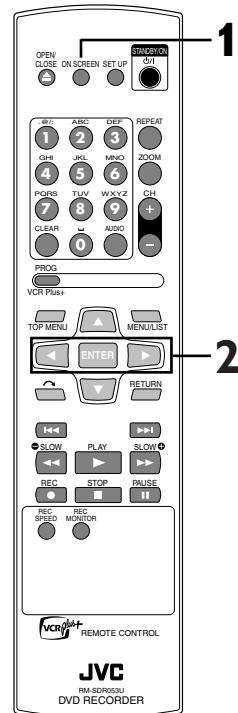

Visual Noise Reduction



1

During playback, press [ON SCREEN].

Display menu will appear.

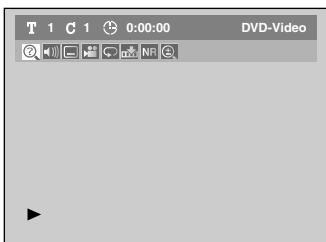

2

Using [◀ / ▶], select  icon. Press [ENTER].

Noise Reduction menu will appear.

3

Using [▲ / ▼], select a desired option. Press [ENTER].

Your setting will be activated.

This function reduces visual noise. When playing back discs recorded in long time mode such as SLP or SEP mode, select "Type 1" or "Type 2". ("Type 2" is more effective.)

When playing back discs with a few noises such as DVD-Video discs, select "OFF".

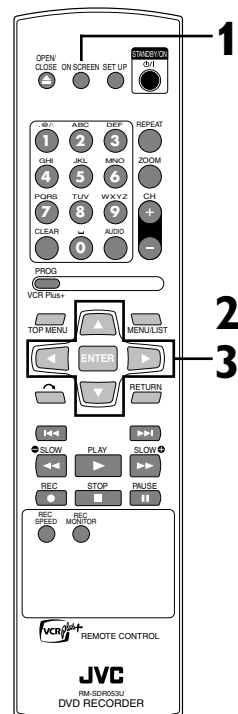

Guide to a title list

Title list allows you to check the titles recorded on the disc easily. You can choose a title to play it back from this screen and easily edit the titles as you prefer.

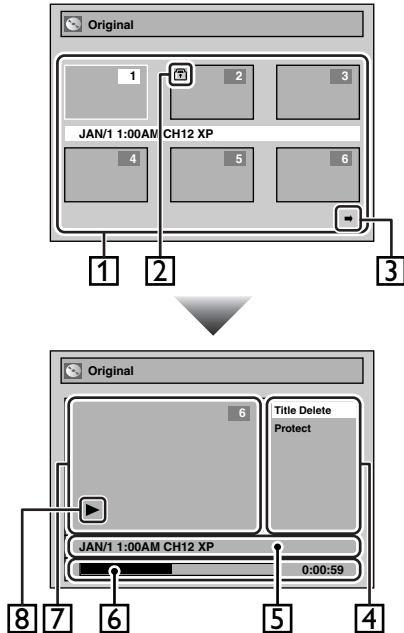

1. Titles recorded on the disc can be selected for editing by pressing **[ENTER]** with the cursor on the title.
2. Protect icon, which appears when the title has been protected (original titles only).
3. The arrow icon, which means the title list has a next or a previous page. Press **[◀ / ▶]** or **[◀◀ / ▶▶]** by following direction of the icon.
4. Features for editing titles. The available menus depend on the disc type and the format type. An unavailable item is grayed out.
5. The details of the title. Title name can be changed on the Playlist.
6. Time status bar of the title.
After exiting the edit mode, you can resume playback from the point you stopped for editing.
7. The thumbnail of the title selected from the title list.
• The selected title will be played back automatically.
8. Playback status of the current disc.

Editing discs in Video mode

You can edit discs in Video mode for the following items. Be sure that once you edit titles, you cannot change them back to the original ones.

- Deleting titles (Refer to page 58)
- Putting names on titles (Refer to page 59)
- Setting or clearing chapter markers (Refer to page 60)

Note

- Once a disc is finalized, editing the disc or recording to the disc will not be available. (Except DVD-RW discs in VR mode.)
- A playlist is not available with the DVD-R discs and DVD-RW discs in Video mode.

Editing discs in VR mode

For discs in VR mode, you can use either “Original” menu or “Playlist” menu, which is created from the original, for editing.

Editing original titles

The following items are available for editing of the original titles.

- Deleting titles (Refer to page 61)
- Setting titles to protect (Refer to page 62)
- Releasing titles from protecting (Refer to page 63)

Editing playlists

You can create a playlist from original titles, in order to edit as you prefer without losing original titles.

The following items are available for editing on a playlist.

- Deleting titles (Refer to page 64)
- Deleting parts of titles (Refer to page 65)
- Putting names on titles (Refer to page 66)
- Setting or clearing chapter markers (Refer to page 67)
- Setting pictures for thumbnails (Refer to page 68)
- Dividing a title (Refer to page 69)
- Combining titles (Refer to page 70)
- Adding titles to a playlist (Refer to page 71)
- Deleting a playlist (Refer to page 71)

Note

- Once-edited original titles will not remain as recorded originally. When you want to leave the original as it is, edit the playlist.

After you finish all editing, press **[SET UP]** to exit the editing mode. “Writing to Disc” appears momentarily. If you open the disc tray, or press **[STANDBY/ON Ⓞ/I]** to turn off the unit, or when a recording error occurs after editing, “Writing to Disc” also appears.

Deleting titles



You can delete titles which you do not need anymore.

Be advised that the titles once deleted cannot be recovered.

In Video mode, recordable disc space of DVD-RW disc will increase when the last title on the title list is deleted. However, deleting the last title will not change recordable disc space of DVD-R discs.

For DVD-R or DVD-RW (in Video mode) discs once finalized, the title list cannot be selected for editing.

1
Press [SET UP]. Using [▲ / ▼], select “Disc”. Press [ENTER]. Disc menu will appear.

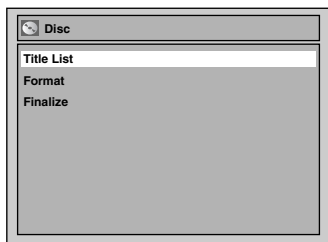

2
Using [▲ / ▼], select “Title List”. Press [ENTER]. Title list will appear.

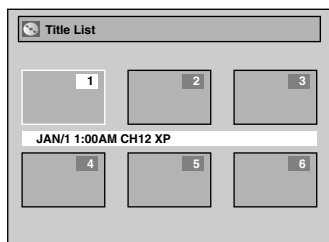

3
Using [▲ / ▼ / ◀ / ▶], select a desired title. Press [ENTER]. Edit menu will appear.

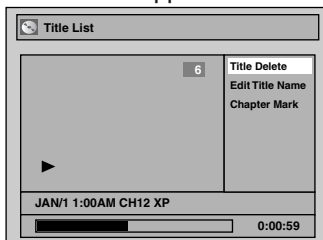

- You cannot select “Chapter Mark” when a DVD-R disc is inserted into the unit.

4
Using [▲ / ▼], select “Title Delete”. Press [ENTER]. Confirmation window will appear.

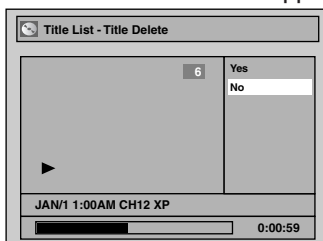

5
Using [▲ / ▼], select “Yes”. Press [ENTER]. Title will be deleted.

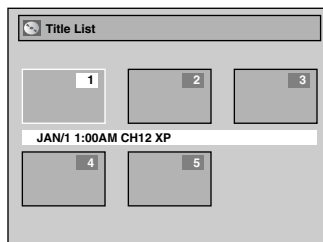

6
After this operation is completed, press [SET UP] to exit.

Writing the data on the disc will start momentarily.

This operation may take a while to be completed.

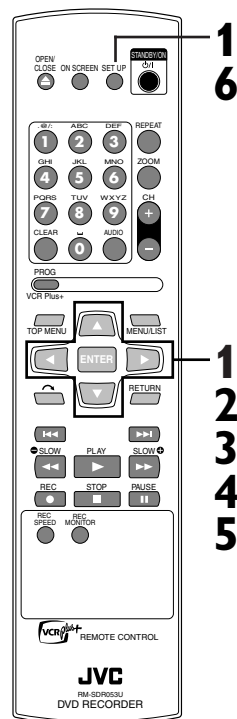

Editing discs in Video mode (cont'd)

Putting names on titles



You can name titles and change the names from this menu. The names you put on the titles will be displayed on a titlelist.

1

Follow steps 1 to 3 on page 58 to display the Edit menu.

Using **[▲ / ▼]**, select **“Edit Title Name”**. Press **[ENTER]**.

A window for entering a title name will appear.

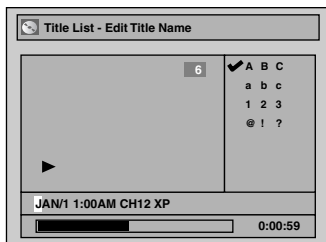

2

To enter a title name, follow the steps of **“Guide to edit title name”** on this page.

character set

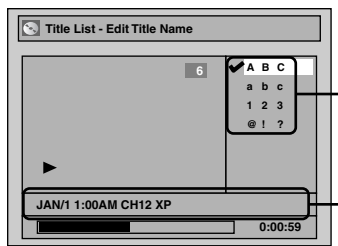

area for entering title names

When you finish entering a title name, press **[ENTER]**. Confirmation window will appear.

3

Using **[▲ / ▼]**, select **“Yes”**. Press **[ENTER]**.

The name you entered will be activated.

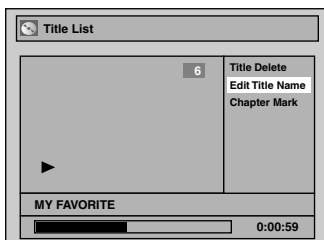

4

After this operation is completed, press **[SET UP]** to exit.

Writing the data on the disc will start momentarily.

This operation may take a while to be completed.

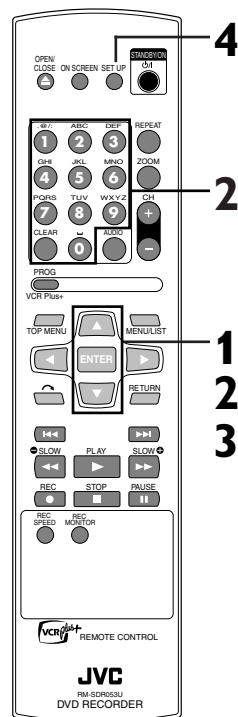

[Guide to edit title name]

[Step1]: Select a desired character set using **[▲/▼]**, then press **[ENTER]**.

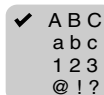

[Step2]: Follow the list below, press the **Number buttons** repeatedly until the desired letter appears. e.g. character set : **A B C**

Select	ABC	abc	123	@ ! ?
0	<space>	<space>	0	<space>
1	-	-	1	! " # \$ % & ' () * + , - . / : ; < = > ? @ [] ^ _ { }
2	ABC	abc	2	-
3	DEF	def	3	-
4	GHI	ghi	4	-
5	JKL	jkl	5	-
6	MNO	mno	6	-
7	PQRS	pqrs	7	-
8	TUV	tuv	8	-
9	WXYZ	wxyz	9	-

Note: Undefined letters in a title name are shown by **“*”**. If you delete them, adjoining letters may change to **“*”** or other.

- Character set will be changed to the **“@!?”** automatically if you press **1** after you selected the **“ABC”** or **“abc”** mode.
- If you want to mix different character sets in one title, repeat steps 1 to 2 above.
- To delete letters, press **[CLEAR]** repeatedly. Hold **[CLEAR]** to delete all letters.
- To go on to the next entering area for letters, press **[▶]**.
- You can enter up to 30 letters.

Editing discs in Video mode (cont'd)

Setting or clearing chapter markers



You can put chapter markers on each title and use them for the chapter search.

You can specify time interval for chapter markers for titles last more than 5 minutes.

1

Follow steps 1 to 3 on page 58 to display the Edit menu.

Using [\blacktriangle / \blacktriangledown], select “Chapter Mark”. Press [ENTER].

Option window will appear.

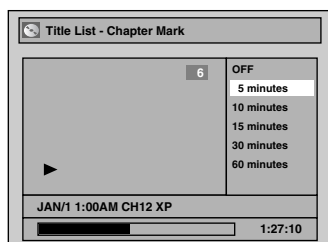

2

Using [\blacktriangle / \blacktriangledown], select a desired time. Press [ENTER].

Confirmation window will appear.

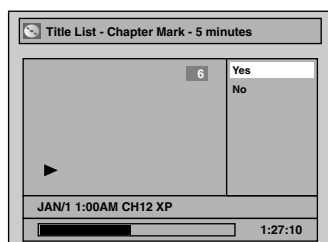

3

Using [\blacktriangle / \blacktriangledown], select “Yes”. Press [ENTER].

Chapter markers will be added. If you select “OFF” at step 2, all the chapter markers will be erased.

4

After this operation is completed, press [SET UP] to exit.

Writing the data on the disc will start momentarily.

This operation may take a while to be completed.

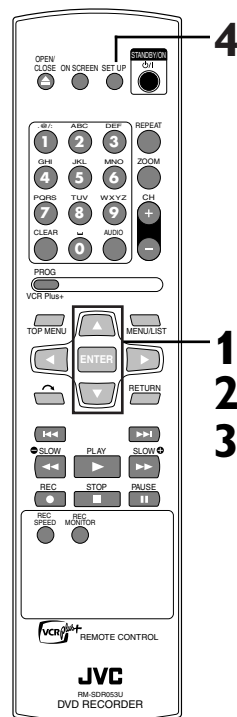

Note

- You cannot select a time interval for markers beyond a length of the title.
- The interval between markers may slightly deviate from the one specified at step 2.
- A chapter marker may be delayed according to the recording content.

Deleting titles



When a title is deleted from an original list in VR mode, the recordable disc space will increase.

Be advised that the titles once deleted cannot be recovered.

1
Press [SET UP]. Using [▲ / ▼], select “Disc”. Press [ENTER].
Disc menu will appear.



2
Using [▲ / ▼], select “Original”. Press [ENTER].
Original list will appear.

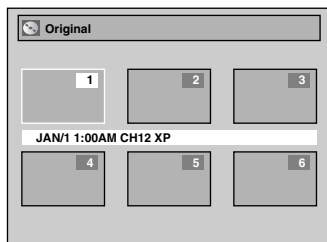

3
Using [▲ / ▼ / ◀ / ▶], select a desired title. Press [ENTER].
Original menu will appear.

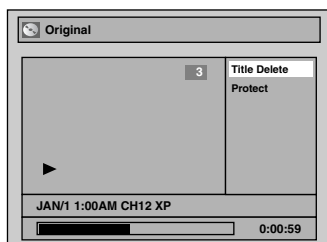

4
Using [▲ / ▼], select “Title Delete”. Press [ENTER].
Confirmation window will appear.

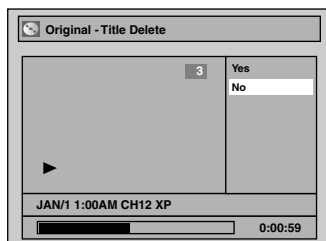

5
Using [▲ / ▼], select “Yes”. Press [ENTER].
Title will be deleted.

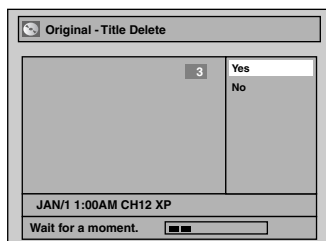

6
After this operation is completed, press [SET UP] to exit.
Writing the data on the disc will start momentarily.

This operation may take a while to be completed.

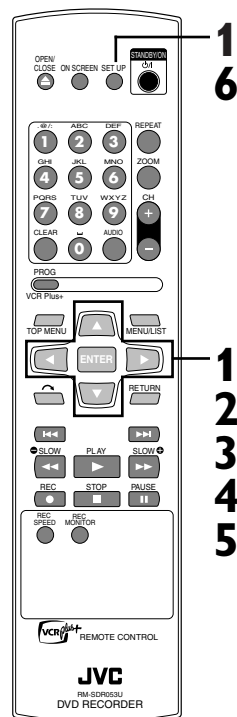

Note

- When a title is deleted from an Original list, corresponding title on the Playlist(s) will be also deleted.

Editing

Editing discs in VR mode (Original) (cont'd)

Setting titles to protect



To prevent accidental editing or title erasing, you can protect the contents in the Original menu.

1

Follow steps 1 to 3 on page 61 to display the Original menu.

Using [\blacktriangle / \blacktriangledown], select “Protect”. Press [ENTER].

Confirmation window will appear.

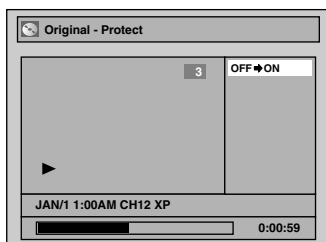

2

Confirm the indication “OFF → ON”. Press [ENTER].

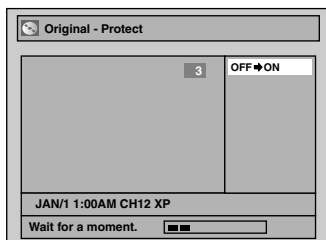

The key icon will appear on the title in the Original list.

3

After this operation is completed, press [SET UP] to exit.

Writing the data on the disc will start momentarily.

This operation may take a while to be completed.

To protect a whole disc (DVD-RW VR mode Only) :

Select “Disc Protect” from Disc menu, then select “Yes”.

Refer to “Setting a disc to protect” on page 39.

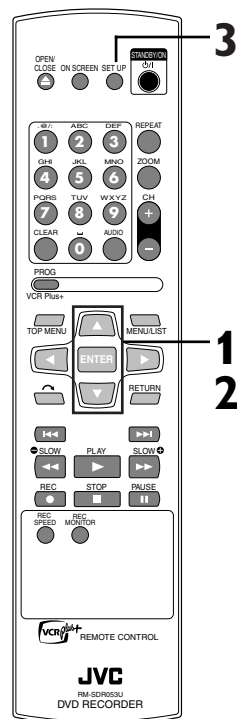

Editing discs in VR mode (Original) (cont'd)

Releasing titles from protecting



You can cancel the title-protecting.

1

Follow steps 1 to 3 on page 61 to display the Original menu.

A “” icon is shown on the protected titles.

- “Protect” is already highlighted.

Press [ENTER].

Confirmation window will appear.

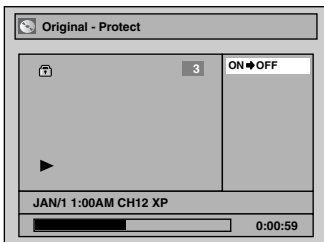

2

Confirm the indication “ON → OFF”. Press [ENTER].

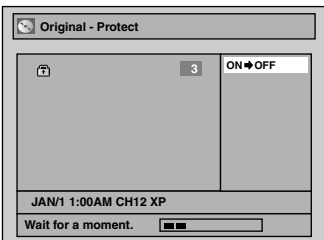

The key icon will disappear from the title in the Original list.

3

After this operation is completed, press [SET UP] to exit.

Writing the data on the disc will start momentarily.

This operation may take a while to be completed.

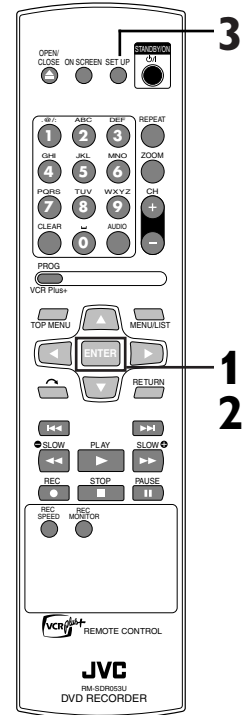

Deleting titles



In VR mode, even if a title is deleted from a Playlist, the original title will remain on the Original list, and recordable disc space will not increase.

1

Press [SET UP]. Using [▲ / ▼], select “Disc”. Press [ENTER].
Disc menu will appear.

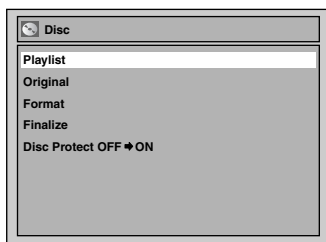

2

Using [▲ / ▼], select “Playlist”. Press [ENTER].
Playlist will appear.

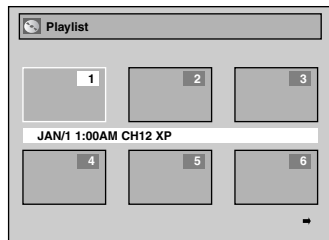

3

Using [▲ / ▼ / ◀ / ▶], select a desired title. Press [ENTER].
Playlist menu will appear.

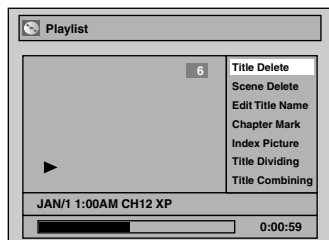

4

Using [▲ / ▼], select “Title Delete”. Press [ENTER].
Confirmation window will appear.

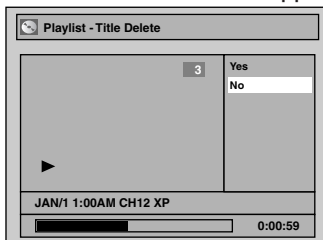

5

Using [▲ / ▼], select “Yes”. Press [ENTER].
Title will be deleted.

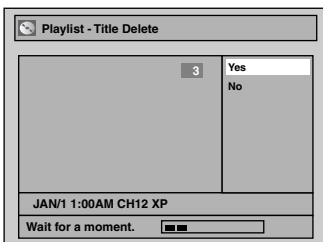

6

After this operation is completed, press [SET UP] to exit.

Writing the data on the disc will start momentarily.

This operation may take a while to be completed.

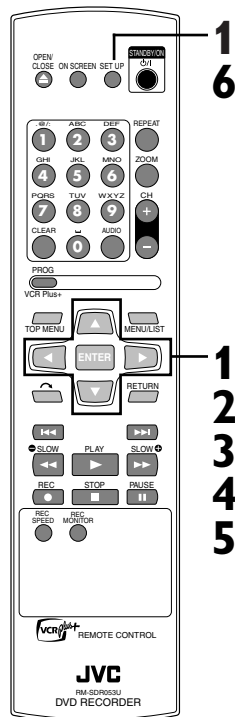

Deleting parts of titles



You can delete a specific part of a title.

Even if a part of a title is deleted from the playlist, the original title will remain as it was, and recordable disc space will not increase.

1 Follow steps 1 to 3 on page 64 to display the Playlist menu.
Using **[▲ / ▼]**, select “Scene Delete”. Press **[ENTER]**.
Option window will appear.

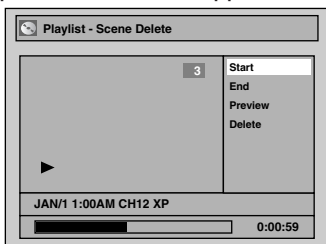

2 Use **[◀◀ / ▶▶]**, **[REW ◀◀]**, **[FWD ▶▶]**, **[PLAY ▶]** and **[PAUSE II]** to decide the start point, then press **[ENTER]**.

Then use **[◀◀ / ▶▶]**, **[REW ◀◀]**, **[FWD ▶▶]**, **[PLAY ▶]** and **[PAUSE II]** again to move to the end point and press **[ENTER]**.
The cursor will move to “Preview.”

The bar at the bottom of the screen indicates the total and the elapsed time of the title. The area selected for deletion will be indicated in red during the preview.

Press **[ENTER]** again to start the preview.

You can check the result of the deletion by preview.

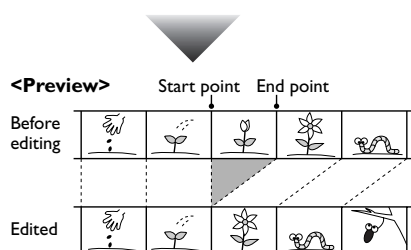

3 Using **[▲ / ▼]**, select “Delete”. Press **[ENTER]**.
Confirmation window will appear.

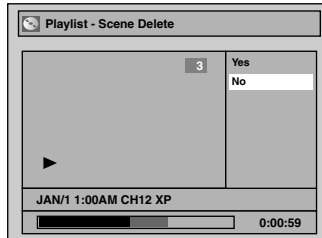

4 Using **[▲ / ▼]**, select “Yes”. Press **[ENTER]**.
Part of a title will be deleted.

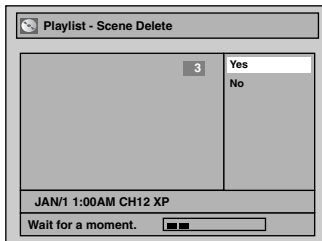

5 After this operation is completed, press **[SET UP]** to exit.
Data will be written onto the disc momentarily.

This operation may take a while to be completed.

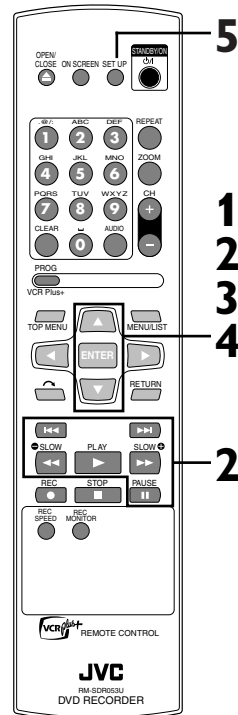

Note
• You cannot select “Scene Delete” when the number of chapter markers exceeds 900.

Editing

Editing discs in VR mode (Playlist) (cont'd)

Putting names on titles



You can name titles and change the names in this menu. The names you put on the titles will be displayed on a title list.

1

Follow steps 1 to 3 on page 64 to display the Playlist menu.

Using **[▲ / ▼]**, select “Edit Title Name”. Press **[ENTER]**.

A window for entering a title name will appear.

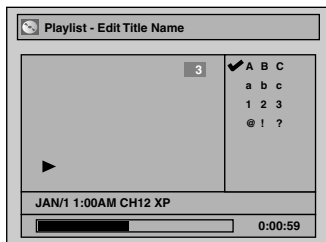

2

To enter a title name, follow the steps of “Guide to edit title name” on this page.

character set

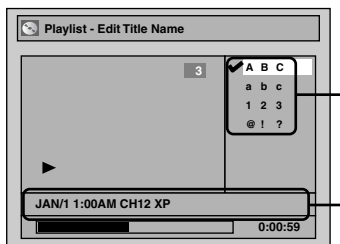

area for entering title names

When you finish entering a title name, press **[ENTER]**. Confirm window will appear.

3

Using **[▲ / ▼]**, select “Yes”. Press **[ENTER]**.

The name you entered will be activated.

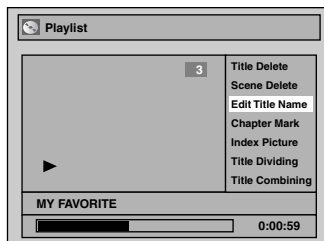

4

After this operation is completed, press **[SET UP]** to exit.

Writing the data on the disc will start momentarily.

This operation may take a while to be completed.

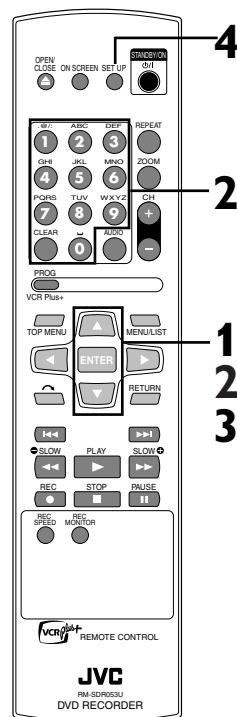

[Guide to edit title name]

[Step1]: Select a desired character set using **[▲/▼]**, then press **[ENTER]**.

✓ A B C
a b c
1 2 3
@ ! ?

[Step2]: Follow the list below, press the **Number buttons** repeatedly until the desired letter appears.

e.g. character set : A B C

Select Press	ABC	abc	123	@ ! ?
0	<space>	<space>	0	<space>
1	-	-	1	! " # \$ % & ' () * + , - . / : ; < = > ? @ [] ^ _ { }
2	ABC	abc	2	-
3	DEF	def	3	-
4	GHI	ghi	4	-
5	JKL	jkl	5	-
6	MNO	mno	6	-
7	PQRS	pqrs	7	-
8	TUV	tuv	8	-
9	WXYZ	wxyz	9	-

press 2
A B C A...

Note: Undefined letters in a title name are shown by “*”. If you delete them, adjoining letters may change to “*” or other.

- Character set will be changed to the “@!?” automatically if you press 1 after you selected the “ABC” or “abc” mode.
- If you want to mix different character sets in one title, repeat steps 1 to 2 above.
- To delete letters, press **[CLEAR]** repeatedly. Hold **[CLEAR]** to delete all letters.
- To go on to the next entering area for letters, press **[▶]**.
- You can enter up to 30 letters.

Setting or clearing chapter markers



You can put chapter markers on each title and can use them for the chapter search.

You can put a chapter marker anywhere you want until the total number of the markers reaches 999.

1

Follow steps 1 to 3 on page 64 to display the Playlist menu.

Using **[▲ / ▼]**, select **"Chapter Mark"**. Press **[ENTER]**.

Option window will appear.

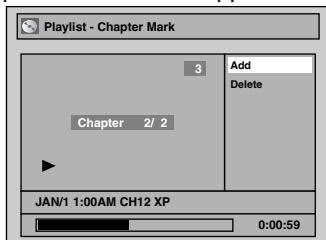

2

Use **[◀◀ / ▶▶]**, **[REW ◀◀]**, **[FWD ▶▶]**, **[PLAY ▶]** and **[PAUSE II]** to decide the point for a new chapter marker.

Or, use **[◀◀ / ▶▶]** to decide a chapter marker that you will delete. Select **"Add"** or **"Delete"** accordingly using **[▲ / ▼]**, then press **[ENTER]**.

Confirmation window will appear.

<Add>:

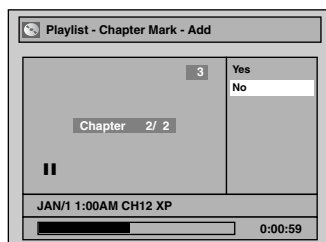

<Delete>:

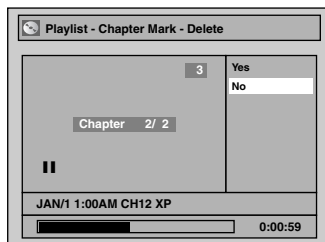

- You cannot delete the first chapter of each title.

3

Using **[▲ / ▼]**, select **"Yes"**. Press **[ENTER]**.

When you select **"Add"** at step 2, a new chapter marker will be added at the point you have decided.

<Add>:

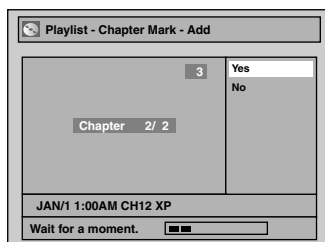

When you select **"Delete"** at step 2, the chapter marker you have selected will be deleted.

<Delete>:

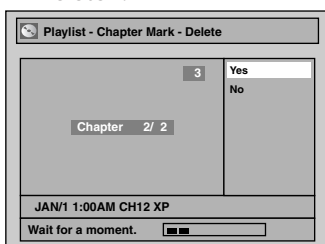

4

After this operation is completed, press **[SET UP]** to exit.

Writing the data on the disc will start momentarily.

This operation may take a while to be completed.

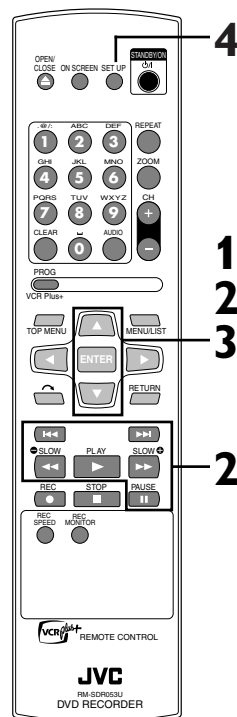

Setting pictures for thumbnails



You can set an image picture for each title as a thumbnail. It helps you remember the contents of the title during playback. The default setting chooses the first scene of each title as the thumbnail.

1

Follow steps 1 to 3 on page 64 to display the Playlist menu.

Using [**▲** / **▼**], select “Index Picture Set”.

Use [**◀◀** / **▶▶**], [**REW** **◀◀**], [**FWD** **▶▶**], [**PLAY** **▶**] and [**PAUSE** **||**] to decide the picture you want to select as thumbnail. Then press [**ENTER**].

Confirmation window will appear.

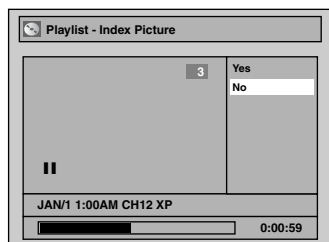

2

Using [**▲** / **▼**], select “Yes”. Press [**ENTER**].

A picture for thumbnail will be set.

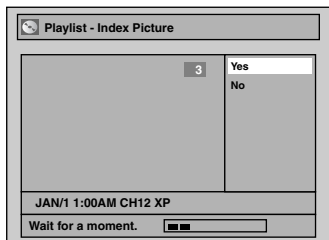

3

After this operation is completed, press [**SET UP**] to exit.

Writing the data on the disc will start momentarily.

This operation may take a while to be completed.

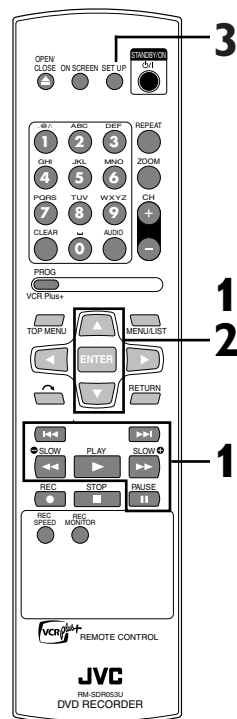

Note

- If a selected picture as thumbnail is deleted by deleting a part of a title, a default picture will automatically replace it.

Dividing a title



You can divide a title into two new titles.

1

Follow steps 1 to 3 on page 64 to display the Playlist menu.

Use [**◀◀** / **▶▶**], [**REW** **◀◀**], [**FWD** **▶▶**], [**PLAY** **▶**] and [**PAUSE** **||**] to decide the point at which you will divide the title.

Using [**▲** / **▼**], select “Title Dividing”. Press [**ENTER**].

Confirmation window will appear.

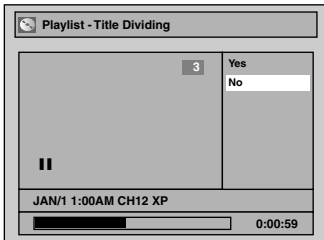

2

Using [**▲** / **▼**], select “Yes”. Press [**ENTER**].

The title will be divided into two new titles.

Both title names are identical and index pictures are reset to the first scene of each title.

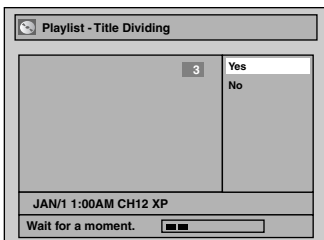

3

After this operation is completed, press [**SET UP**] to exit.

Writing the data on the disc will start momentarily.

This operation may take a while to be completed.

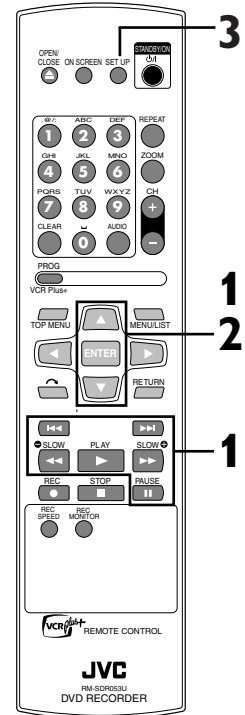

Note

- If a disc contains the maximum number of recordings (99), you cannot divide any titles.
- You cannot divide the titles if the total number of the chapters have already reached 999.

Combining titles



You can combine two titles into a single title.

1

Follow steps 1 to 3 on page 64 to display the Playlist menu.

Using [**▲** / **▼**], select “Title Combining”. Press [**ENTER**].

Title Combining setting window will appear.

The selected title will be grayed out, and the frame of the next title becomes yellow.

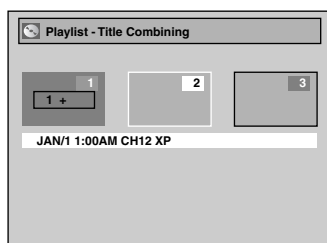

2

Using [**▲** / **▼** / **◀** / **▶**], select another title to combine.

Press [**ENTER**].

Confirmation window will appear.

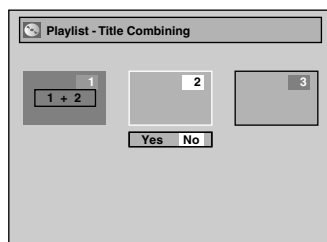

3

Using [**▲** / **▼**], select “Yes”. Press [**ENTER**].

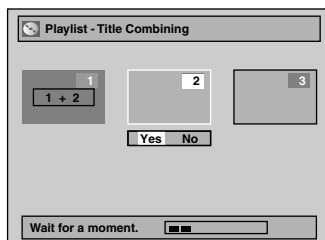

Two titles will be combined into a single title.

4

After this operation is completed, press [**SET UP**] to exit.

Writing the data on the disc will start momentarily.

This operation may take a while to be completed.

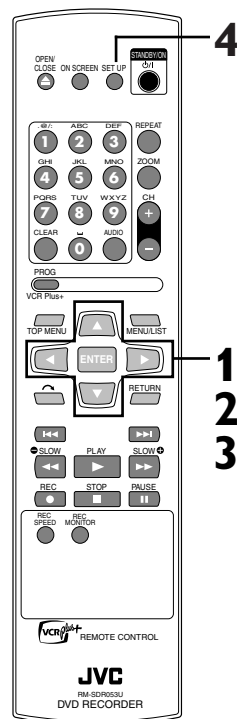

Note

- If the number of chapter markers in the combined title exceeds 999, the combination will be rejected.
- If one of two titles in the original is deleted, the combined new title will be deleted.
- The name of the title selected first will become the name of the combined title.
- The title selected first will be the first point of the combined title.

Editing discs in VR mode (Playlist) (cont'd)

Adding titles to a Playlist



You can add or delete a title on the Playlist as you prefer.

You can add up to 99 titles to a Playlist.

1
Follow steps 1 to 2 on page 64 to display the Playlist. “Add New Title” “Delete Playlist” menu will appear next to the last title. Using **[▲ / ▼ / ◀ / ▶]**, select “Add New Title”. Press **[ENTER]**.

Original list will appear.

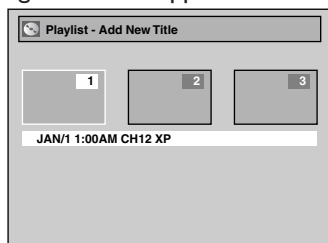

2

Using **[▲ / ▼ / ◀ / ▶]**, select a desired title. Press **[ENTER]**.



The selected title will appear to the Playlist.

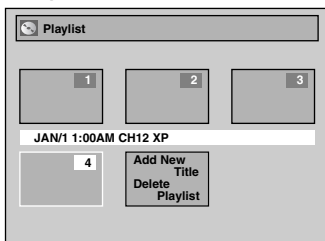

3

After this operation is completed, press **[SET UP]** to exit.

Writing the data on the disc will start momentarily.

This operation may take a while to be completed.

Note

- When a Playlist contains 99 titles or more or 999 chapters or more, “Add New Title” cannot be selected.
- To delete a title from Playlist, refer to “Deleting titles” on page 64.
- To delete a Playlist, refer to “Deleting a Playlist” on this page.

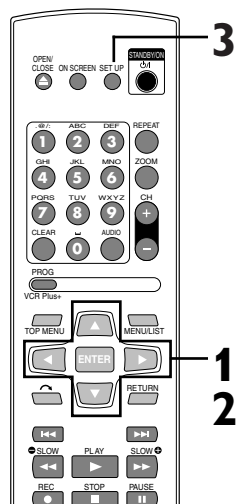

Deleting a Playlist



A Playlist can be deleted if it is no longer needed.

1
Follow steps 1 to 2 on page 64 to display the Playlist. “Add New Title” “Delete Playlist” menu will appear next to the last title. Using **[▲ / ▼ / ◀ / ▶]**, select “Delete Playlist”. Press **[ENTER]**.

Confirmation window will appear.

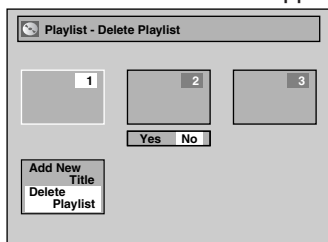

2

Using **[◀ / ▶]**, select “Yes”. Press **[ENTER]**.

A Playlist will be deleted.

3

After this operation is completed, press **[SET UP]** to exit.

Writing the data on the disc will start momentarily.

This operation may take a while to be completed.

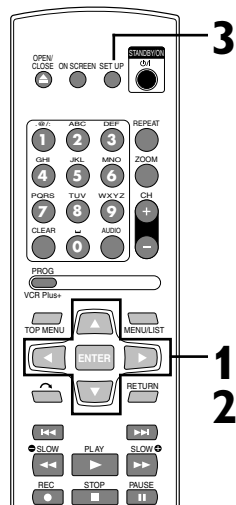

Note

- Deleting a Playlist will not increase the recordable disc space.

Changing the Setting menu

Tour of the Setting menu

The following table shows the items which you can change the setting and their default settings. Refer to the following table for your convenience.

Setting menu	Items (highlight is the default)	Contents	
1.Language setting ➡ Pages 73-74	Disc Menu Language	English <input checked="" type="checkbox"/> French Spanish ⋮	Set the language for disc menu.
	Audio Language	Original <input checked="" type="checkbox"/> English French ⋮	Set the language for audio.
	Subtitle Language	OFF <input checked="" type="checkbox"/> English French ⋮	Set the language for subtitles.
2.Display setting ➡ Pages 74-75	OSD Language	English <input checked="" type="checkbox"/> Français Español	Set the language for OSD (On-Screen Display).
	FL Dimmer	Auto <input checked="" type="checkbox"/> Bright Dark	Set the brightness of front display.
	Screen Saver	OFF <input checked="" type="checkbox"/> 5 minutes 10 minutes ⋮	Set the idling time before the screen saver starts.
3.Audio setting ➡ Pages 75-77	Digital Out	PCM 48kHz <input checked="" type="checkbox"/> 96kHz	Set whether the sound recorded in 96kHz will be down sampled in 48kHz.
		Dolby Digital PCM Stream <input checked="" type="checkbox"/>	Set the type of sound signal output from the digital audio output jack.
		DTS ON <input checked="" type="checkbox"/> OFF	Set whether or not DTS signal will be output.
	Dynamic Range Control	ON <input checked="" type="checkbox"/> OFF	Compressing the range of sound volume.
	Fast Forward with Audio	ON <input checked="" type="checkbox"/> OFF	Set whether or not to output sound during fast forward playback.
4.Parental setting ➡ Pages 77-78	Parental Lock	All <input checked="" type="checkbox"/> level 8 to 1	Set the parental level for DVD disc playback.
	(Change password)	Enter the current four-digit password.	Set and change the password.

Note

- If you change the settings in the Setting menu, the information of contents stays on even after the power is switched off or the disc tray is opened or closed.
- An item which is not currently available is grayed out in Setting menus.

Changing the Setting menu

Language setting

Press **[STOP ■]** if you are playing back a disc.

1

Press **[SET UP]**.

Easy Setting Menu or Advanced Setting Menu will appear.
If Advanced Setting Menu is displayed, proceed to step 3.

2

Using **[▲ / ▼]**, select “Advanced Setting Menu”. Press **[ENTER]**.

Advanced Setting Menu will appear.

3

Using **[▲ / ▼]**, select “Playback”. Press **[ENTER]**.

Option window will appear.

4

Using **[▲ / ▼]**, select a desired item. Press **[ENTER]**.

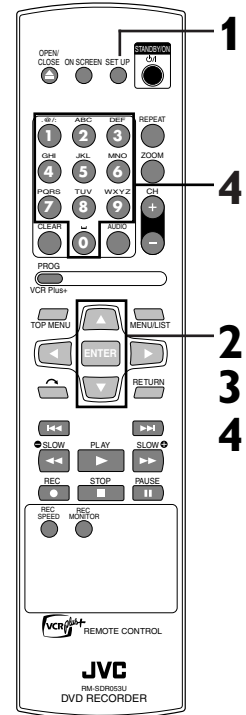

Disc Menu Language (Default : English)

Set the language for Disc Menu.

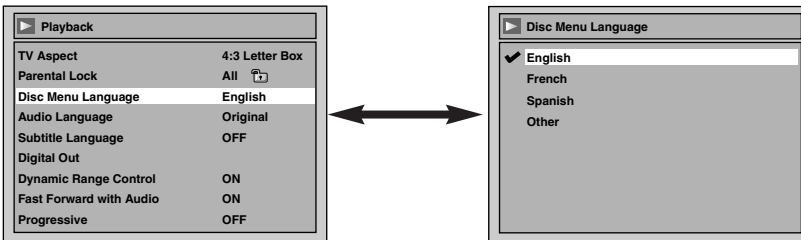

- Using **[▲ / ▼]**, select a language. Press **[ENTER]**.
Your setting will be activated.

Audio Language (Default : Original)

Set the Audio language.

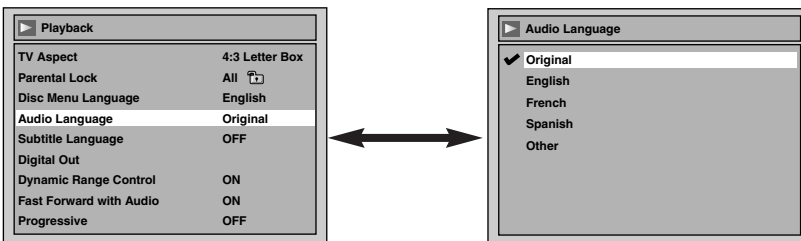

- Using **[▲ / ▼]**, select a setting. Press **[ENTER]**.
Your setting will be activated.
- When Original is selected, the audio language will be the disc's default language.

Instructions continue on the next page.

Changing the Setting menu

Language setting (cont'd)

Subtitle Language (Default : OFF)

Set the Subtitle language.

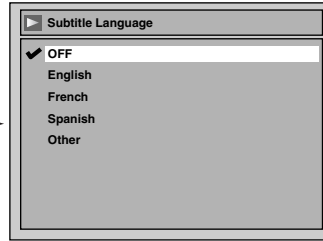
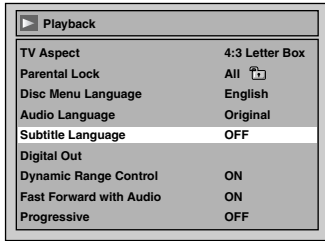

• Using [▲ / ▼], select a language. Press [ENTER]. Your setting will be activated.

If “Other” is selected, enter 4-digit code using the Number buttons.

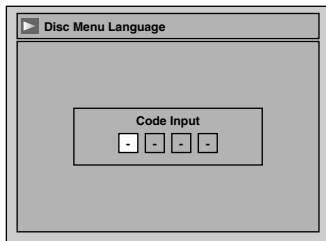

• When you finish entering the code, press [ENTER]. Refer to the language code table on page 84.

Note

- Only the languages supported by the disc can be selected.
- Audio Language setting may not be available on some discs.
- You can also change or switch off the subtitles on a DVD disc also from the disc menu if it is available.
- Press [CLEAR] or [◀] to erase numbers entered incorrectly.

5

Press [SET UP] to exit.

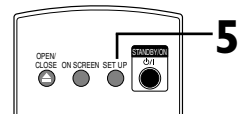

Display setting

Press [STOP ■] if you are playing back a disc.

1

Press [SET UP].

Easy Setting Menu or Advanced Setting Menu will appear. If Advanced Setting Menu is displayed, proceed to step 3.

2

Using [▲ / ▼], select “Advanced Setting Menu”. Press [ENTER].

Advanced Setting Menu will appear.

3

Using [▲ / ▼], select “Display”. Press [ENTER].

Option window will appear.

4

Using [▲ / ▼], select a desired item. Press [ENTER].

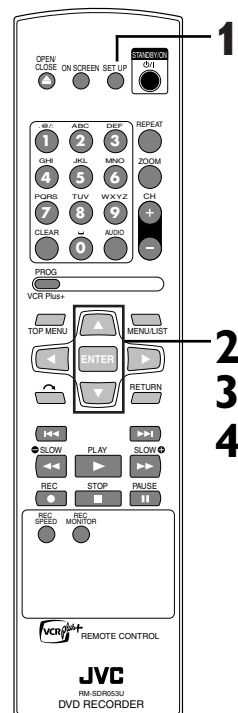

Changing the Setting menu

Display setting (cont'd)

OSD Language (Default : English)

Set the language for OSD.

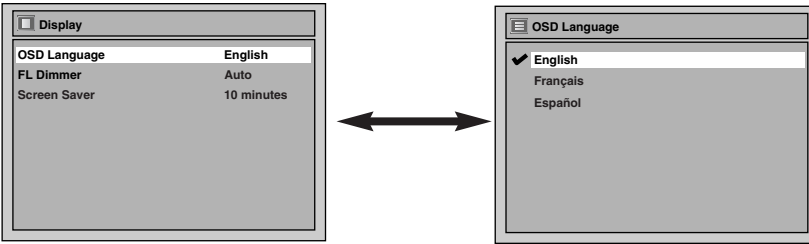

- Using **[▲ / ▼]**, select a language. Press **[ENTER]**. Your setting will be activated.

FL Dimmer (Default : Auto)

Set the idling time before the screen saver starts.

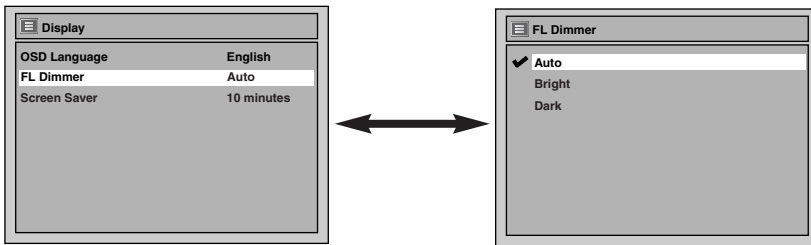

- Using **[▲ / ▼]**, select a setting. Press **[ENTER]**. Your setting will be activated.
- You can choose one among "Auto", "Bright" and "Dark". When "Auto" is selected, the display will be shown brighter when the power is on and darker when the power is off.

Screen Saver (Default : 10 minutes)

Set the the idling time before the screen saver starts.

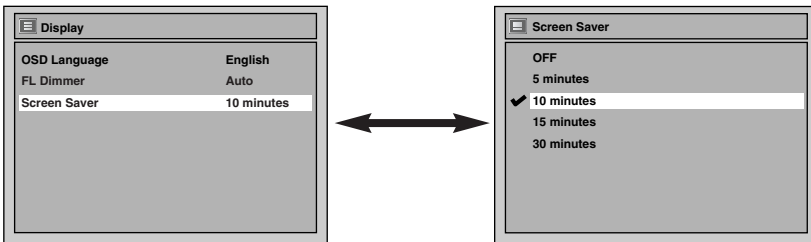

- Using **[▲ / ▼]**, select a setting. Press **[ENTER]**. Your setting will be activated.

5

Press **[SET UP]** to exit.

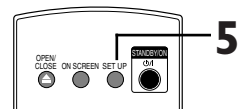

Audio setting

Choose the appropriate Audio settings for your equipment.

Press **[STOP ■]** if you are playing back a disc.

1

Press **[SET UP]**.

Easy Setting Menu or Advanced Setting Menu will appear.
If Advanced Setting Menu is displayed, proceed to step 3.

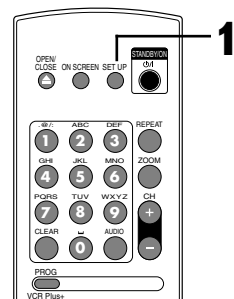

Instructions continue on the next page.

Changing the Setting menu

Audio setting (cont'd)

2
Using [▲ / ▼], select “Advanced Setting Menu”. Press [ENTER].

Advanced Setting Menu will appear.

3
Using [▲ / ▼], select “Playback”. Press [ENTER].

Option window will appear.

4
Using [▲ / ▼], select a desired item. Press [ENTER].

Digital Out

Set the digital audio output.

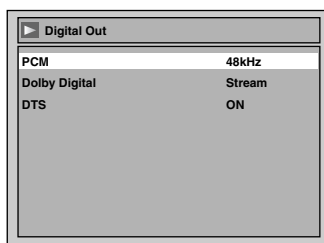
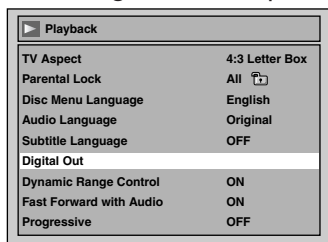

• Using [▲ / ▼], select a setting. Press [ENTER].

Option window will appear.
Proceed to steps A, B or C.

Note

- Dynamic Range Control is available only on the discs which are recorded in Dolby Digital format.

A Settings for PCM (Default : 48kHz)

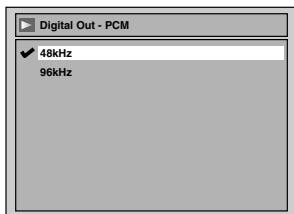

• Using [▲ / ▼], select a setting. Press [ENTER].

Your setting will be activated.

48kHz : If your amplifier/decoder is NOT compatible with 96kHz PCM, select “48kHz”. 96kHz sound will be output in 48kHz.

96kHz : If your amplifier/decoder is compatible with 96kHz PCM, select “96kHz”. 96kHz sound will be output.

Note

When playing back disc with copyright protection

- Even if you select “96kHz”, the sound will be down sampled at 48kHz.

B Settings for Dolby Digital (Default : Stream)

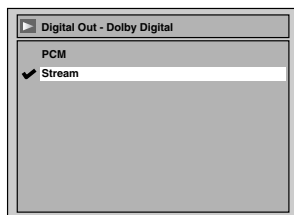

• Using [▲ / ▼], select a setting. Press [ENTER].

Your setting will be activated.

PCM : Convert the Dolby Digital into PCM (2 channel).

When your amplifier/decoder is NOT compatible with Dolby Digital, set to “PCM”.

Stream : Outputs Dolby Digital signals.

When your amplifier/decoder is compatible with Dolby Digital, set to “Stream”.

Note

When playing back a DVD-RW disc recorded in VR mode

- If the audio on a disc is recorded in Dolby Digital format, set “Dolby Digital” to “PCM” so that you can switch to main (L), sub audio (R), or a mix of both (L/R) with your amplifier/decoder.

C Settings for DTS (Default : ON)

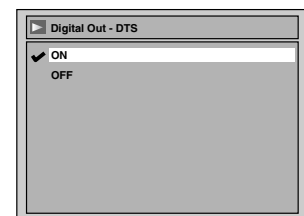

• Select a setting using [▲ / ▼], then press [ENTER].

Your setting will be activated.

ON : Outputs DTS signals.

When your amplifier/decoder is compatible with DTS, set to “ON”.

OFF : No DTS signal is output.

When your amplifier/decoder is NOT compatible with DTS, set to “OFF”.

Changing the Setting menu

Audio setting (cont'd)

Dynamic Range Control (Default : ON)

Set to "ON" to compress the range between soft and loud sounds.

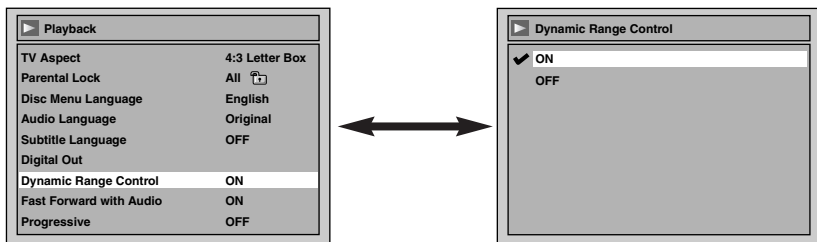

• Using [▲ / ▼], select a setting. Press [ENTER].
Your setting will be activated.

Fast Forward with Audio (Default : ON)

Set to "ON" to output the sound during playback in x1.5 fast forward.

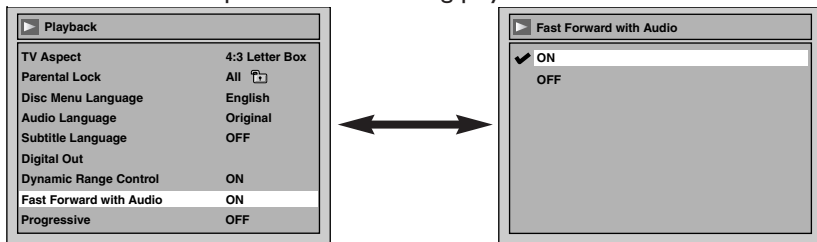

• Using [▲ / ▼], select a setting. Press [ENTER].
Your setting will be activated.

5
Press [SET UP] to exit.

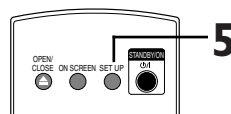

Settings for Parental lock level

Some DVD-Video discs feature a Parental Lock level. Playback will stop if the disc's general rating exceeds the level you set. It will require you to enter a password before the disc will be played back. This function prevents your children from viewing inappropriate materials.

Press [STOP ■] if you are playing a disc.

1
Press [SET UP].
Easy Setting Menu or Advanced Setting Menu will appear.
If Advanced Setting Menu is displayed, proceed to step 3.

2
Using [▲ / ▼], select "Advanced Setting Menu". Press [ENTER].
Advanced Setting Menu will appear.

3
Using [▲ / ▼], select "Playback". Press [ENTER].
Option window will appear.

4
Using [▲ / ▼], select "Parental Lock". Press [ENTER].

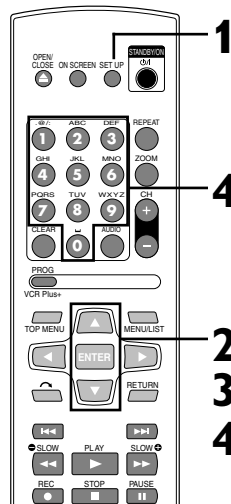

Note

- Parental lock may not be available on some discs.
- For some DVDs, it may be difficult to find if they are compatible with parental lock. Be sure to check if the parental lock operates in the way that you have set.
- Record the password in case you forget it.

Instructions continue on the next page.

Changing the Setting menu

Settings for Parental lock level (cont'd)

Parental Lock (Default : All)

Set the Parental Lock level.

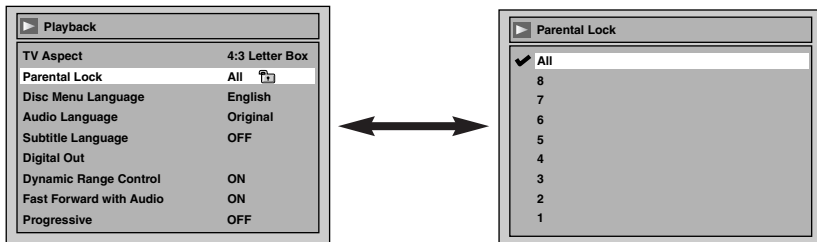

• Using **[▲ / ▼]**, change the parental level. Press **[ENTER]**.

Option window will appear. Proceed to step A or B.

A A password has not been set yet

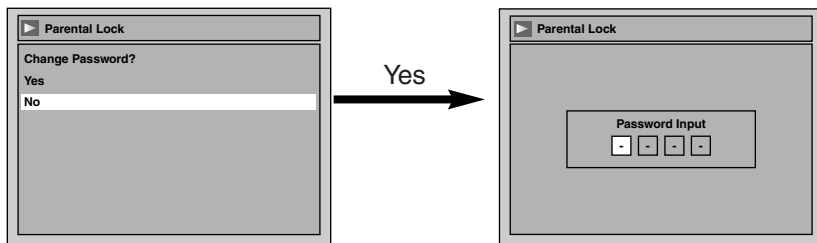

• Using **[▲ / ▼]**, select “Yes”. Using the **Number buttons**, enter a new password. Press **[ENTER]**.

Your setting will be activated.

• If you select “No”, proceed to step 5.

B A password has been set already

Change the password

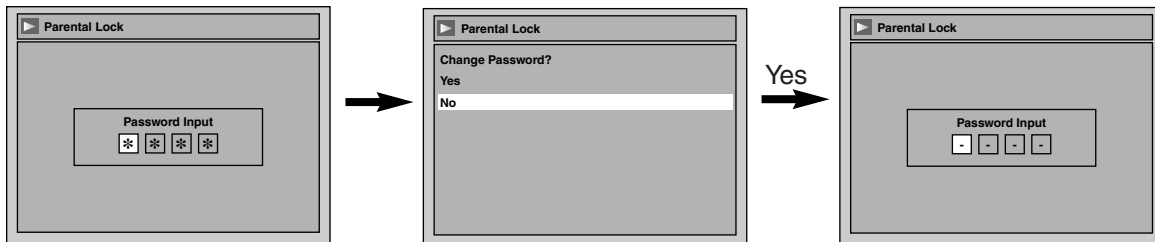

• Using the **Number buttons**, enter the current password.

• If you select “No”, proceed to step 5.

• Using **[▲ / ▼]**, select “Yes”. Using the **Number buttons**, enter a new password. Press **[ENTER]**.

Your setting will be activated.

5

Press **[SET UP]** to exit.

Note

- Press **[CLEAR]** to erase numbers entered incorrectly.
- Do not use 4, 7, 3, 7 as password.
- When you forget the password or you want to clear all settings in Parental lock, enter 4,7,3,7 using the **Number buttons** in input window at step B. Password will be cleared and parental levels will be set to All.

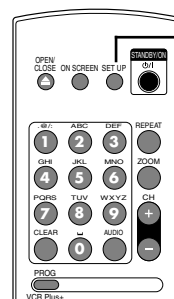

Troubleshooting

Before requesting service for this unit, check the table below for a possible cause of the problem you are experiencing. Some simple checks or a minor adjustment on your part may eliminate the problem and restore proper performance.

Symptom	Remedy
Power The power does not turn on.	<ul style="list-style-type: none"> • Check that the AC power cord is connected securely. • (In case of power failure) Check the breaker.
Picture There is no picture.	<ul style="list-style-type: none"> • Re-connect the connecting cord securely. • The connecting cords are damaged. • The Setup Display appears. Press [RETURN] to turn off the display. • Check the connection to your TV (page 13). • Check if the INTERLACE/PROGRESSIVE mode is set correctly according to your TV (page 14). • Switch the input selector on your TV (such as to "LINE1") so that the signal from this unit appears on the TV screen.
Picture noise appears.	<ul style="list-style-type: none"> • The disc is dirty or flawed. • If the picture output signal from the unit passes through your VCR before reaching your TV, or if you are connected to a combination TV/VIDEO player, the copy-protection signal applied to some DVD programs could affect picture quality. If you still experience this problem even when you connect the unit directly to your TV, try connecting the unit to your TV's S-VIDEO input.
TV program reception does not fill the screen.	<ul style="list-style-type: none"> • Try to set the channels with "Auto Preset" in the Setting menu (page 18). • Select a channel of any TV program using [CH + / -].
TV program pictures are distorted.	<ul style="list-style-type: none"> • Adjust TV antenna. • Adjust the picture (see the TV's instruction manual). • Place the unit and TV farther apart. • Place the TV and any bunched antenna cables farther apart.
TV channels cannot be changed.	<ul style="list-style-type: none"> • Switch the input to TV. • Connect the antenna cable correctly (page 14).
Playback picture is distorted.	<ul style="list-style-type: none"> • Keep the equipment which may cause electrical disturbances, such as a cellular phone, away.
The playback picture or TV program from the equipment connected through the unit is distorted.	<ul style="list-style-type: none"> • If the playback picture output from a DVD player, VCR or tuner goes through the unit before reaching your TV, the copy-protection signal applied to some programs could affect picture quality. Disconnect the playback equipment in question and connect it directly to your TV.
Sound There is no sound.	<ul style="list-style-type: none"> • The disc is dirty or flawed. • Re-connect all connections securely. • The connecting cord is damaged. • Check the connections to the amplifier input. • The input source setting on the amplifier is incorrect. • The recorder is in pause mode or in Slow-motion Play mode. • The recorder is in fast forward or fast reverse mode. • If the audio signal does not come through the COAXIAL DIGITAL AUDIO OUTPUT PCM / BITSTREAM jack, check the Audio settings (pages 75-77).
Sound is noisy.	<ul style="list-style-type: none"> • The disc is dirty or flawed.
No DTS sound on digital output.	<ul style="list-style-type: none"> • Change the setting menu for DTS to ON.
No DTS sound from analog output.	<ul style="list-style-type: none"> • This unit has no analog sound output when playing the selected DTS sound mode.
Remote control The remote control does not function.	<ul style="list-style-type: none"> • Batteries are weak. • There are obstacles between the remote control and the unit. • The remote control is far from the unit. • There are no batteries in the remote control. • Turn on the unit. • The remote control is not pointed at the remote sensor on the unit.

Troubleshooting (cont'd)

Symptom	Remedy
Playback The unit does not play back the disc.	<ul style="list-style-type: none"> • No disc is inserted. • A blank disc is inserted. • The disc is upside down. Insert the disc with the labeled side facing up. • The disc is not correctly inserted. • The unit cannot play back certain discs (such as a CD-ROM) (page 42). • The region code on the DVD-Video does not match the ones on the unit (page 42). • Moisture has condensed inside the unit. Remove the disc and leave the unit turned on for about two hours until the moisture evaporates (page 4). • If the disc was recorded on another recorder, the unit cannot play back the disc unless it is finalized (page 40).
Playback image freezes for a second.	<ul style="list-style-type: none"> • During the playback of two layered disc, picture may freeze for a moment when the 1st layer switches to the 2nd layer. This is not a malfunction.
The disc does not start playback from the beginning.	<ul style="list-style-type: none"> • Resume playback was activated (page 46). Press [STOP ■] twice. • You have inserted a disc whose Title menu or DVD menu automatically appears on the TV screen when it is inserted for the first time.
The unit starts playing back the disc automatically.	<ul style="list-style-type: none"> • The DVD-Video provides an auto playback function.
Some functions such as Stop, Search, or Slow-motion Play cannot be performed.	<ul style="list-style-type: none"> • Depending on the disc, you may not be able to do some of these operations. See the instruction manual supplied with the disc.
The language for the sound track cannot be changed.	<ul style="list-style-type: none"> • Multilingual tracks are not recorded on the DVD-Video, DVD-R or DVD-RW being played back. • The DVD-Video prohibits the changing of the language for the sound track. • Try changing the language using the DVD-Video's menu.
The subtitle language cannot be changed or turned off.	<ul style="list-style-type: none"> • Multilingual subtitle are not recorded on the DVD-Video. • The DVD-Video prohibits changing of the subtitles. • Try changing the subtitles using the DVD-Video's menu.
The angles cannot be changed.	<ul style="list-style-type: none"> • Multi-angles are not recorded on the DVD-Video being played back. • The angle-change operation is possible as long as the disc contains a multi-angle portion. Actual change can be performed when the portion has come up. • The DVD-Video prohibits changing angles. • Try changing the angles using the DVD-Video's menu.
Recording/Timer Recording/Editing	
The channel cannot be changed from the channel you are recording.	<ul style="list-style-type: none"> • Set the TV's input to "TV."
Recording does not start immediately after you press [REC ●] .	<ul style="list-style-type: none"> • An unused DVD-R or DVD-RW was inserted. It takes a while for the unit to automatically format a DVD-RW.
Nothing was recorded even though you set the timer setting correctly.	<ul style="list-style-type: none"> • There was a power failure during recording. • The unit's internal clock stopped due to a power failure that lasted for more than 30 seconds. • Reset the clock (pages 23, 24). • Disconnect the AC power cord from the AC outlet, and connect it again. • The program contains copy protection signals that restricts copying. • The timer setting overlapped with another setting that was set later or has priority.
Recording does not stop immediately after you press [STOP ■] .	<ul style="list-style-type: none"> • It will take a few seconds for the unit to input disc data before recording can stop.
Timer Recording is not completed or did not start from the beginning.	<ul style="list-style-type: none"> • The timer setting overlapped with another setting that was set later or has priority (page 36). • Disc space was not enough.

Troubleshooting (cont'd)

Symptom	Remedy
Others The unit does not operate properly.	<ul style="list-style-type: none"> When static electricity, etc., causes the unit to operate abnormally, unplug the unit and then plug it again.
The disc tray does not open when you press [OPEN/CLOSE ▲] .	<ul style="list-style-type: none"> It may take a few seconds for the disc tray to open after you have recorded or edited a disc. This is because the unit is adding disc data to the disc.
"Repairing" appears on the display.	<ul style="list-style-type: none"> If there is a power failure or unplugging during recording, finalizing, formatting or editing (even after "Wait for a moment." message is disappeared), a Repairing process will begin automatically soon after turning the unit on again. It may take several minutes up to about four hours.

• If above remedies do not solve the problem, please call the Service Center for help.

Error message	Cause	Solution
<div style="border: 1px solid black; padding: 2px; width: fit-content;">Disc Error</div> <p>— Please eject the disc. — Playback feature may not be available on this Disc.</p>	Unplayable disc is inserted in the unit. The disc is upside down.	Insert the standardized disc which bears the marks on page 42. Insert the disc with the labeled side facing up.
<div style="border: 1px solid black; padding: 2px; width: fit-content;">Region Error</div> <p>— Please eject the disc. — Playback is not authorized in your region.</p>	The region of the DVD-Video disc does not match the ones on the unit.	Insert the DVD-Video disc with region code 1 or ALL.
<div style="border: 1px solid black; padding: 2px; width: fit-content;">Parental Lock On</div> <p>The current selected parental level prohibits playback.</p>	The current selected parental level in the Setting Menu prohibits playback.	Check the "Parental Lock" setting (pages 77-78).
<div style="border: 1px solid black; padding: 2px; width: fit-content;">Recording Error</div> <p>This program is not allowed to be recorded.</p>	The recording function encountered a copy prohibited program.	You cannot record copy prohibited programs.
<div style="border: 1px solid black; padding: 2px; width: fit-content;">Recording Error</div> <p>This program is not recordable in Video mode.</p>	You are trying to record a copy-once program onto the DVD-RW disc in Video mode.	Set "DVD-RW Recording Format" to "VR mode"(page 28).
<div style="border: 1px solid black; padding: 2px; width: fit-content;">Recording Error</div> <p>Can not record on this disc.</p>	You are trying to record onto the disc which is unrecordable, or the disc status is unable to record. The disc is dirty. The disc is damaged.	Insert a recordable disc, and ensure the disc status satisfies the recording requirements (pages 26-27). Clean the disc with a cleaning cloth. Replace the disc.
<div style="border: 1px solid black; padding: 2px; width: fit-content;">Recording Error</div> <p>This program is not allowed to be recorded on this disc.</p>	You are trying to record a copy-once program onto the DVD-RW disc which is not compatible with CPRM.	Insert a ver.1.1 or 1.2 CPRM compatible DVD-RW disc.
<div style="border: 1px solid black; padding: 2px; width: fit-content;">Recording Error</div> <p>This disc is protected and not recordable.</p>	You are trying to record onto the protected disc.	Cancel the disc protect setting in the Disc Setting menu (page 39).
<div style="border: 1px solid black; padding: 2px; width: fit-content;">Recording Error</div> <p>Disc is full. (No area for new recording)</p>	You are trying to record onto the disc with no recording space left.	Insert the recordable disc with enough recording space.

Others

Troubleshooting (cont'd)

Error message	Cause	Solution
<div style="border: 1px solid black; padding: 2px; text-align: center;">Recording Error</div> <p>You cannot record more than 99 titles on one disc. (The maximum is 99)</p>	<p>You are trying to record onto the disc on which the number of recording titles already reached the maximum (99).</p>	<p>Delete unnecessary titles (pages 58, 61).</p>
<div style="border: 1px solid black; padding: 2px; text-align: center;">Recording Error</div> <p>You cannot record more than 999 chapters on one disc. (The maximum is 999)</p>	<p>You are trying to record onto the VR mode DVD-RW disc on which the number of recording chapters already reached to the maximum (999).</p>	<p>This unit cannot delete the original chapter. Delete unnecessary chapter marker using other DVD recorders. Delete unnecessary titles from the Original list (page 61).</p>
<div style="border: 1px solid black; padding: 2px; text-align: center;">Recording Error</div> <p>You cannot record on this disc as Control Information is full.</p>	<p>This disc has no space to write the Control Information when recording or deleting contents.</p> <p>When editing has been repeatedly performed, the control Information area may become full even if the recording area still has enough space.</p>	<p>Delete unnecessary titles (pages 58, 61).</p>
<div style="border: 1px solid black; padding: 2px; text-align: center;">Recording Error</div> <p>You cannot record on this disc as Power Calibration Area is full.</p>	<p>When recordings are performed repeatedly onto an unstable disc, this area may become full.</p> <p>Every time you insert a disc for recording, the disc's working area will be taken up. And if you repeat this frequently, it will be used up sooner and you may not be able to record full 99 titles.</p>	<p>Insert a new disc.</p>
<div style="border: 1px solid black; padding: 2px; text-align: center;">Recording Error</div> <p>This disc is already finalized.</p>	<p>You are trying to record onto the disc already finalized.</p>	<p>Undo finalizing of the disc (page 40).</p>

* If you are still having trouble with this unit after checking Troubleshooting, write down the error code and the error description, and call our helpline mentioned on the back cover to locate an Authorized Service Center.

Analog audio

An electrical signal that directly represents sound. In contrast, digital audio which can be an electrical signal, but is an indirect representation of sound. See also Digital audio.

Aspect ratio

The width of a TV screen relative to its height. Conventional TVs are 4:3 (in other words, the screen is almost square); widescreen models are 16:9 (the screen is almost twice as wide as it is high).

Chapter

Just as a book is split up into several chapters, a title on a DVD disc is usually divided into chapters. See also Title.

Component video output

This is a video signal format that conveys each of three principal colors of light (red, blue and green) through different signal lines. This allows the viewers to experience picture colors as original as it is. There are several signal formats, including Y/Pb/Pr and Y/Cb/Cr.

CPRM (Content Protection for Recordable Media)

This is a format used to record copy-once programs. By recording coded data on the area of DVD discs that ordinary writing software cannot write on, it prevents copy-once programs from being recorded repeatedly on different media.

Digital audio

An indirect representation of sound by numbers. During recording, the sound is measured at discrete intervals (44, 100 times a second for CD audio) by an analog-to-digital converter, generating a stream of numbers. On playback, a digital-to-analog converter generates an analog signal based on these numbers. See also Sampling frequency and Analog audio.

Dolby Digital

The system developed by Dolby Laboratories to compress digital sound. It offers you sound of stereo(2ch) or multi-channel audio (up to 5.1ch).

DTS (Digital Theater System)

DTS is a 5.1 channel surround sound system, but it is different from Dolby Digital. The formats were developed by Digital Theater System, Inc.

Finalize

To make recorded contents on DVD discs possible to be played back on DVD players. With this unit, it is possible to finalize DVD-RW/DVD-R discs.

PCM (Pulse Code Modulation)

PCM is a format that converts audio into digital data. It is mainly used for Audio CDs and DAT. This unit can play back sounds as realistic as possible by converting even compressed Dolby Digital and MPEG audio to PCM.

Playlist

From this list you can play back contents of a disc in your desired order or sequence. Also it allows to search a specific scene directly.

Progressive Scan (525p/480p)

A type of display that does not split each frame into fields, and instead scans directly through all the scanlines of each frame in order. Progressive Scan provides less flickering and higher image resolution than traditional (525i/480i) TV signals. Refer to page 14 for instructions on selective Progressive Scan mode.

Regions code

Regions associate discs and players with particular areas of the world. This unit will only play back discs that have compatible region codes. You can find the region code of your unit by looking at the rear panel. Some discs are compatible with more than one region (or all regions).

Sampling frequency

The rate which sound is measured by a specified interval to turn it into digital audio data. The numbers of sampling in one second defines as sampling frequency. The higher the rate, the better the sound quality is.

SAP (Secondary Audio Program)

Sub-audio channel which is delivered separately from main-audio channel. This audio channel is used as an alternate in bilingual broadcasting.

S-Video output

It delivers independently each signal of color(C) and luminance(Y) to TV as video signals, so that higher-quality picture will be materialized.

Title (DVD only)

A collection of chapters on DVD disc. See also chapter.

Track

Audio CDs use tracks to divide the content of a disc. The DVD equivalent is called a chapter. See also Chapter.

VCR Plus+ system

Allows you to set a timer recording by entering a PlusCode number found in participating TV listings.

Others

Language code

Language	Code	Language	Code	Language	Code	Language	Code
Abkhazian	4748	French	5264	Lithuanian	5866	Sindhi	6550
Afar	4747	Frisian	5271	Macedonian	5957	Singhalese	6555
Afrikaans	4752	Galician	5358	Malagasy	5953	Siswat	6565
Albanian	6563	Georgian	5747	Malay	5965	Slovak	6557
Amharic	4759	German	5051	Malayalam	5958	Slovenian	6558
Arabic	4764	Greek	5158	Maltese	5966	Somali	6561
Armenian	5471	Greenlandic	5758	Maori	5955	Spanish	5165
Assamese	4765	Guarani	5360	Marathi	5964	Sundanese	6567
Aymara	4771	Gujarati	5367	Moldavian	5961	Swahili	6569
Azerbaijani	4772	Hausa	5447	Mongolian	5960	Swedish	6568
Bashkir	4847	Hebrew	5569	Nauru	6047	Tagalog	6658
Basque	5167	Hindi	5455	Nepali	6051	Tajik	6653
Bengali; Bangla	4860	Hungarian	5467	Norwegian	6061	Tamil	6647
Bhutani	5072	Icelandic	5565	Occitan	6149	Tatar	6666
Bihari	4854	Indonesian	5560	Oriya	6164	Telugu	6651
Bislama	4855	Interlingua	5547	(Afan) Oromo	6159	Thai	6654
Breton	4864	Interlingue	5551	Panjabi	6247	Tibetan	4861
Bulgarian	4853	Inupiak	5557	Pashto; Pushto	6265	Tigrinya	6655
Burmese	5971	Irish	5347	Persian	5247	Tonga	6661
Byelorussian	4851	Italian	5566	Polish	6258	Tsonga	6665
Cambodian	5759	Japanese	5647	Portuguese	6266	Turkish	6664
Catalan	4947	Javanese	5669	Quechua	6367	Turkmen	6657
Chinese	7254	Kannada	5760	Rhaeto-Romance	6459	Twi	6669
Corsican	4961	Kashmiri	5765	Romanian	6461	Ukrainian	6757
Croatian	5464	Kazakh	5757	Russian	6467	Urdu	6764
Czech	4965	Kinyarwanda	6469	Samoan	6559	Uzbek	6772
Danish	5047	Kirghiz	5771	Sangho	6553	Vietnamese	6855
Dutch	6058	Kirundi	6460	Sanskrit	6547	Volapuk	6861
English	5160	Korean	5761	Scots Gaelic	5350	Welsh	4971
Esperanto	5161	Kurdish	5767	Serbian	6564	Wolof	6961
Estonian	5166	Laothian	5861	Serbo-Croatian	6554	Xhosa	7054
Faroese	5261	Latin	5847	Sesotho	6566	Yiddish	5655
Fiji	5256	Latvian; Lettish	5868	Setswana	6660	Yoruba	7161
Finnish	5255	Lingala	5860	Shona	6560	Zulu	7267

Frequently Asked Questions

- Can I record on CD-RW/R?
No, this unit records only DVDs.
- Can I play back DVD-Video that is bought in another country?
Possible only if the region code of the disc is 1 and ALL.
- Is this unit MP3 compatible?
No.
- Can I connect the unit to my PC?
No, you cannot control the unit by PCs.

Specifications

General

System	DVD-Video, DVD-RW/R, CD-DA, CD-RW/R
Power requirements	AC120V, 60 Hz
Power consumption	20 W (standby: 2.7 W)
Weight	5.06 lbs (2.3 kg)
Dimensions (width x height x depth)	17 3/16" x 2 5/8" x 9 5/8" (435 x 66 x 244 mm)
Operating temperature	41F° to 104F° (5°C to 40°C)
Operating humidity	less than 80% (no condensation)
TV format	NTSC

Recording

Recording format	Video Recording format (DVD-RW only), Video format (DVD-RW, DVD-R)
Recordable discs	DVD-Rewritable, DVD-Recordable
Video recording format	
Sampling frequency	13.5MHz
Compression format	MPEG
Audio recording format	
Sampling frequency	48kHz
Compression format	Dolby Digital

Tuner

Receivable channels	
VHF	2-13ch
UHF	14-69ch
CATV	C1-C125ch

Input/Output

VHF/UHF antenna input/output terminal	VHF/UHF set 75Ω
Video input	Input 1 (rear), 2 (front)
Input level	1 Vp-p (75Ω)
Jacks	RCA jack
Video output	Output 1
Output level	1 Vp-p (75Ω)
Jack	RCA jack
S-Video input	Input 1 (rear), 2 (front)
Y (luminance) - Input level	1 Vp-p (75Ω)
C (color) - Input level	286 mVp-p (75Ω)
Jacks	4 pin mini DIN
S-Video output	
Y (luminance) - Output level	1 Vp-p (75Ω)
C (color) - Output level	286 mVp-p (75Ω)
Jack	4 pin mini DIN
Component video output	
Output level	Y: 1.0 Vp-p (75Ω), Pb, Pr: 0.7 Vp-p (75Ω)
Jacks	RCA jacks
Audio input	Input 1 (rear), 2 (front) L/R
During audio input	2V rms (Input impedance: more than 22kΩ)
Jacks	RCA jacks
Audio output	Output 1 L/R
During audio output	2V rms (Output impedance: less than 1kΩ)
Jacks	RCA jacks
Digital audio output	
Output level	500 mVp-p (75Ω)
Jacks	RCA jack

Note:

The specifications and design of this product are subject to change without notice.

Others

Memo



LIMITED WARRANTY

USA ONLY

ONLY FOR PRODUCT PURCHASED IN U.S.A.

CONSUMER VIDEO 1-90

JVC COMPANY OF AMERICA (JVC) warrants this product and all parts thereof, except as set forth below ONLY TO THE ORIGINAL RETAIL PURCHASER to be FREE FROM DEFECTIVE MATERIALS AND WORKMANSHIP from the date of original purchase for the period shown below. ("The Warranty Period")

PARTS	1 YR	LABOR	90 DAYS
-------	-------------	-------	----------------

THIS LIMITED WARRANTY IS VALID ONLY IN THE FIFTY (50) UNITED STATES, THE DISTRICT OF COLUMBIA AND IN THE COMMONWEALTH OF PUERTO RICO.

WHAT WE WILL DO:

If this product is found to be defective within the warranty period, JVC will repair or replace defective parts with new or rebuilt equivalents at no charge to the original owner. Such repair and replacement services shall be rendered by JVC during normal business hours at JVC authorized service centers. Parts used for replacement are warranted only for the remainder of the Warranty Period. All products may be brought to a JVC authorized service center on a carry-in basis. Color televisions with a screen size of 27" or greater qualify for in-home service. In such cases, a technician will come to your home and either repair the TV there or remove and return it if it cannot be repaired in your home.

WHAT YOU MUST DO FOR WARRANTY SERVICE:

Please do not return your product to the retailer
Instead, return your product to the JVC authorized service center nearest you. If shipping the product to the service center, please be sure to package it carefully, preferably in the original packaging, and include a brief description of the problem(s). Please call 1-800-252-5722 to locate the nearest JVC authorized service center. Service locations can also be obtained from our website <http://www.jvc.com>. If your product qualifies for in-home service, the service representative will require clear access to the product.

If you have any questions concerning your JVC Product, please contact our Customer Relations Department at 800-252-5722

WHAT IS NOT COVERED:

- This limited warranty provided by JVC does not cover:
1. Products which have been subject to abuse, accident, alteration, modification, tampering, negligence, misuse, faulty installation, lack of reasonable care, or if repaired or serviced by anyone other than a service facility authorized by JVC to render such service, or if affixed to any attachment not provided with the products, or if the model or serial number has been altered, tampered with, defaced or removed;
 2. Initial installation, installation and removal from cabinets or mounting systems.
 3. Operational adjustments covered in the Owner's Manual, normal maintenance, video and audio head cleaning;
 4. Damage that occurs in shipment, due to act of God, and cosmetic damage;
 5. Signal reception problems and failures due to line power surge;
 6. User Removal Memory Devices/Video Pick-up Tubes/CCD Image Sensors are covered for 90days from the date of purchase;
 7. Accessories;
 8. Batteries (except that Rechargeable Batteries are covered for 90 days from the date of purchase);
 9. Products used for commercial purposes, including, but not limited to rental.
 10. Loss of data resultant from malfunction of hard drive or other data storage device.

There are no express warranties except as listed above.

THE DURATION OF ANY IMPLIED WARRANTIES, INCLUDING THE IMPLIED WARRANTY OF MERCHANTABILITY, IS LIMITED TO THE DURATION OF THE EXPRESS WARRANTY HEREIN.

JVC SHALL NOT BE LIABLE FOR ANY LOSS OF USE OF THE PRODUCT, INCONVIENCE, OR ANY OTHER DAMAGES, WHETHER DIRECT, INCIDENTAL OR CONSEQUENTIAL (INCLUDING, WITHOUT LIMITATION, DAMAGE TO TAPES, RECORDS OR DISCS) RESULTING FROM THE USE OF THIS PRODUCT, OR ARISING OUT OF ANY BREACH OF THIS WARRANTY. ALL EXPRESS AND IMPLIED WARRANTIES, INCLUDING THE WARRANTIES OF MERCHANTABILITY AND FITNESS FOR PARTICULAR PURPOSE, ARE LIMITED TO THE WARRANTY PERIOD SET FORTH ABOVE.

Some states do not allow the exclusion of incidental or consequential damages or limitations on how long an implied warranty lasts, so these limitations or exclusions may not apply to you. This warranty gives you specific legal rights and you may also have other rights which vary from state to state.

JVC COMPANY OF AMERICA
 DIVISION OF JVC AMERICAS CORP. <http://www.jvc.com>
 1700 Valley Road
 Wayne, NJ 07470

REFURBISHED PRODUCTS CARRY A SEPARATE WARRANTY, THIS WARRANTY DOES NOT APPLY. FOR DETAIL OF REFURBISHED PRODUCT WARRANTY, PLEASE REFER TO THE REFURBISHED PRODUCT WARRANTY INFORMATION PACKAGED WITH EACH REFURBISHED PRODUCT.

For customer use:

Enter below the Model No. and Serial No. which is located either on the rear, bottom or side of the cabinet. Retain this information for future reference.

Model No. : _____

Serial No. : _____

Purchase date : _____

Name of dealer : _____

TO OUR VALUED CUSTOMER ———

THANK YOU FOR PURCHASING THIS JVC PRODUCT.
WE WANT TO HELP YOU ACHIEVE A PERFECT EXPERIENCE.

**NEED HELP ON HOW TO HOOK UP?
NEED ASSISTANCE ON HOW TO OPERATE?
NEED TO LOCATE A JVC SERVICE CENTER?
LIKE TO PURCHASE ACCESSORIES?**

JVC[®] IS HERE TO HELP!
TOLL FREE: 1(800)252-5722
<http://www.jvc.com>

Remember to retain your Bill of Sale for Warranty Service.

————— **Do not attempt to service the product yourself** —————

Caution

To prevent electrical shock, do not open the cabinet.
There are no user serviceable parts inside.
Please refer to qualified service personnel for repairs.

BT-51005-9
(0904)